

Panasonic®

Operating Instructions

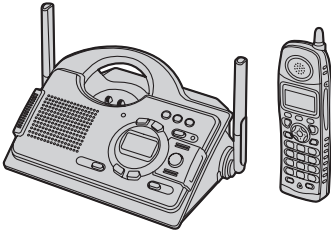

Model shown is KX-TG5438.

5.8 GHz Digital Cordless Answering System

Model No. **KX-TG5438**

5.8 GHz Digital Cordless Answering System
with Dual Handsets

Model No. **KX-TG5439**



This unit is compatible with Caller ID. To use this feature, you must subscribe to the appropriate service offered by your service provider.

Charge the battery for 6 hours before initial use.

Please read these Operating Instructions before using the unit and save for future reference.

For assistance, visit our website: <http://www.panasonic.com> for customers in the U.S.A. or Puerto Rico.

Table of Contents

Introduction

Your phone	4
Accessory information	5
Important safety instructions	6
For best performance	8

Preparation

Connections	9
Battery installation	10
Battery charge	11
Battery replacement	12
Controls and displays	13
Controls	13
Display	15
Setting the date and time	16

Making/Answering Calls

Making calls	17
Answering calls	18
Useful features during a call	19
Voice changer	19
HOLD button	19
MUTE button	19
Voice enhancer	20
Clarity booster	20
Call share (KX-TG5439 only)	20
PAUSE button (for PBX/long distance service users)	21
Flash button	21
For Call Waiting service users	21
Temporary tone dialing (for rotary/pulse service users)	21

Phonebook

Using the phonebook	22
Adding items to the phonebook	22
Calling someone in the phonebook	23
Editing items in the phonebook	23
Erasing items in the phonebook	23
Chain dial feature	24
Copying phonebook items (KX-TG5439 only)	24
Copying an item	24
Copying all items	25

Caller ID Service

Using Caller ID service	26
Ringer ID and light-up ID	26

Caller list	27
Viewing the caller list and calling back	27
Editing a caller's phone number before calling back	28
Storing caller information into the phonebook	29
Erasing caller information	29

Intercom Features

Intercom	30
For KX-TG5438 users	30
For KX-TG5439 users	31
Transferring a call (KX-TG5439 only)	32
Conference calls (KX-TG5439 only)	32

Programmable Settings

Guide to handset programming	33
Ringer settings	34
Handset ringer volume	34
Handset ringer tone	35
Handset interrupt tone	35
Call options	36
Auto talk	36
Voice changer	36
Voice enhancer	37
Caller ID edit	37
Display options	37
Handset LCD contrast	37
Display language	37
Telephone settings	38
Dialing mode	38
Flash time	38
Line mode	38
Other options	39
Handset key tone	39
Re-registering the handset	39
Time adjustment (Caller ID subscribers only)	40
Customer support	40
Programming via direct commands	41
Direct commands chart	41

Answering System Features

Answering system	43
Recording your greeting message	43
Erasing your greeting message	44

Pre-recorded greeting message . . .	44
Turning the answering system on/off . .	44
Screening your calls	44
Listening to messages	45
Listening to messages using the base unit	45
Listening to messages using the handset	46
Memory capacity	47
Remote operation	48
Using the answering system remotely	48
Answering system settings	49
Remote code	49
Ring count	50
Caller's recording time	50
Message alert	51

Useful Information

Wall mounting	52
Base unit	52
Charger unit (KX-TG5439 only)	54
Belt clip	55
Headset (optional)	55
Error messages	56
Troubleshooting	57
General use	57
Programmable settings	57
Making/answering calls, Intercom . .	58
Phonebook	59
Caller ID	59
Answering system	60
Battery charge	61
Power failure	61
Important information about subscription services	62
FCC and other information	63
openLCR service for the Caller IQ feature	65
Technical information	66
Base unit	66
Handset	66
Charger unit (KX-TG5439 only)	66
Warranty	67
Customer services	69

Index

Index	70
-----------------	----

Introduction

Thank you for purchasing a Panasonic cordless telephone.

We recommend keeping a record of the following information for future reference.

Serial No. _____

Date of purchase _____

(found on the bottom of the unit)

Name and address of dealer _____

Attach your purchase receipt here.

Energy Star:

As an ENERGY STAR® Participant, Panasonic has determined that this product meets the ENERGY STAR guidelines for energy efficiency. ENERGY STAR is a U.S. registered mark.



Trademarks:

openLCR, openLCR.com, and the openLCR logo are the trademarks of openLCR.com, Inc.

Your phone

KX-TG5438

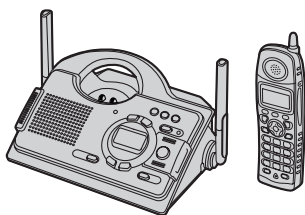

KX-TG5439

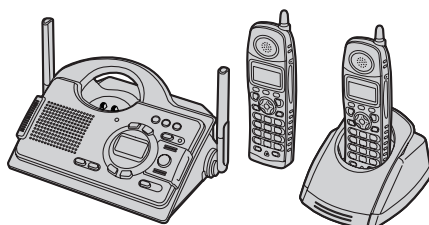

- References in these operating instructions to the “charger” and to the “other handset” are for KX-TG5439 users only.

Accessory information

Included accessories

To order replacement accessories, call 1-800-332-5368.

TTY users (hearing or speech impaired users) can call 1-866-605-1277.

No.	Accessory items	Order number	Quantity		
			KX-TG5438F	KX-TG5438S	KX-TG5439S
①	AC adaptor for base unit	PQLV1Z	1	1	1
②	Telephone line cord	PQJA10075Z	1	1	1
③	Wall mounting adaptor	PQKL10057Z1	1	1	1
④	Battery	HHR-P104	1	1	2
⑤	Handset cover	PQKK10584Z2	1	–	–
		PQKK10584Z3	–	1	2
⑥	Belt clip	PQKE10389Z1	1	1	2
⑦	Charger	PQLV30031ZB	–	–	1
	AC adaptor for charger	KX-TCA1-G	–	–	1

①

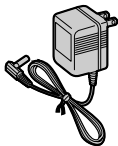

②



③

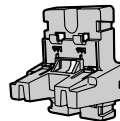

④

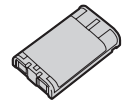

⑤

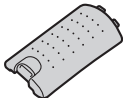

⑥



⑦

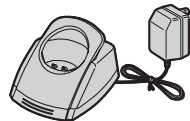

Additional/replacement accessories

Accessory items	Order number
Rechargeable nickel metal hydride (Ni-MH) battery	HHR-P104
Headset	KX-TCA60, KX-TCA86, KX-TCA88, KX-TCA88HA, KX-TCA91, KX-TCA92, or KX-TCA98
Battery back-up power supply	KX-TCA200

Important safety instructions

When using this unit, basic safety precautions should always be followed to reduce the risk of fire, electric shock, or personal injury.

1. Read and understand all instructions.
2. Follow all warnings and instructions marked on this unit.
3. Unplug this unit from power outlets before cleaning. Do not use liquid or aerosol cleaners. Use a damp cloth for cleaning.
4. Do not use this unit near water, for example near a bathtub, wash bowl, kitchen sink, etc.
5. Place the unit securely on a stable surface. Serious damage and/or injury may result if the unit falls.
6. Do not cover slots and openings on the unit. They are provided for ventilation and protection against overheating. Never place the unit near radiators, or in a place where proper ventilation is not provided.
7. Use only the power source marked on the unit. If you are not sure of the type of power supplied to your home, consult your dealer or local power company.
8. Do not place objects on the power cord. Install the unit where no one can step or trip on the cord.
9. Do not overload power outlets and extension cords. This can result in the risk of fire or electric shock.
10. Never push any objects through slots in this unit. This may result in the risk of fire or electric shock. Never spill any liquid on the unit.
11. To reduce the risk of electric shock, do not disassemble this unit. Take the unit to an authorized service center when service is required. Opening or removing covers may expose you to dangerous voltages or other risks.

Incorrect reassembly can cause electric shock when the unit is subsequently used.

12. Unplug this unit from power outlets and refer servicing to an authorized service center when the following conditions occur:
 - A. When the power cord is damaged or frayed.
 - B. If liquid has been spilled into the unit.
 - C. If the unit has been exposed to rain or water.
 - D. If the unit does not work normally by following the operating instructions. Adjust only controls covered by the operating instructions. Improper adjustment may require extensive work by an authorized service center.
 - E. If the unit has been dropped or physically damaged.
 - F. If the unit exhibits a distinct change in performance.
13. During thunderstorms, avoid using telephones except cordless types. There may be a remote risk of an electric shock from lightning.
14. Do not use this unit to report a gas leak, when in the vicinity of the leak.

SAVE THESE INSTRUCTIONS

CAUTION:

Installation

- Never install telephone wiring during a lightning storm.
- Never install telephone jacks in wet locations unless the jack is specifically designed for wet locations.
- Never touch uninsulated telephone wires or terminals unless the telephone line has been disconnected at the network interface.
- Use caution when installing or modifying telephone lines.

- Do not touch the plug with wet hands.
- The AC adaptor is used as the main disconnect device. Ensure that the AC outlet is installed near the unit and is easily accessible.

Battery

To reduce the risk of fire or injury to persons, read and follow these instructions.

- Use only the battery(ies) specified.
- Do not dispose of the battery(ies) in a fire. They may explode. Check with local waste management codes for special disposal instructions.
- Do not open or mutilate the battery(ies). Released electrolyte is corrosive and may cause burns or injury to the eyes or skin. The electrolyte may be toxic if swallowed.
- Exercise care when handling the battery(ies). Do not allow conductive materials such as rings, bracelets or keys to touch the battery(ies), otherwise a short circuit may cause the battery(ies) and/or the conductive material to overheat and cause burns.
- Charge the battery(ies) provided with or identified for use with this product only in accordance with the instructions and limitations specified in this manual.

WARNING:

- To prevent the risk of fire or electrical shock, do not expose this product to rain or any type of moisture.

Medical

- Consult the manufacturer of any personal medical devices, such as pacemakers or hearing aids, to determine if they are adequately shielded from external RF (radio frequency) energy. (The unit operates in the frequency range of 5.76 GHz to 5.84 GHz, and the power output level can range from 0.25 to 0.5 watts.) Do not use

the unit in health care facilities if any regulations posted in the area instruct you not to do so. Hospitals or health care facilities may be using equipment that could be sensitive to external RF (radio frequency) energy.

Splash-resistant (handset only)

The handset is designed to be splash-resistant.

You can use the handset with wet hands.

- Do not immerse in water or leave under running water.
- Keep the handset away from salt water.
- Avoid exposure to prolonged high humidity.
- Since water in headset jack may cause damage, close the headset jack cover when the optional headset is not in use. When the optional headset is connected, do not use the handset with wet hands.
- If the handset is wet, wipe with a soft dry cloth.
- The base unit is not designed to be splash resistant. Do not place the handset on the base unit if the handset is wet.

Shock-resistant (handset only)

The handset is designed to be shock-resistant, however, it should not be thrown or stepped on.

For best performance

Base unit location/noise

The base unit and handset use radio waves to communicate with each other. For maximum distance and noise-free operation, we recommend the following:

- Placing the unit away from electrical appliances such as a TV, personal computer or another cordless phone.
- Placing the base unit in a HIGH and CENTRAL location with no obstructions such as walls.
- Raising the antennas vertically.
- If you use the handset near a microwave oven which is being used, noise may be heard. Move away from the microwave oven and closer to the base unit.
- If you use the handset near another cordless phone's base unit, noise may be heard. Move away from the other cordless phone's base unit and closer to your base unit.

Environment

- Keep the unit away from electrical noise generating devices, such as fluorescent lamps and motors.
- The unit should be kept free from excessive smoke, dust, high temperature and vibration.
- The unit should not be exposed to direct sunlight.
- Do not place heavy objects on top of the unit.
- When you leave the unit unused for a long period of time, unplug this unit from power outlet.
- The unit should be kept away from heat sources such as heaters, kitchen stoves, etc. It should not be placed in rooms where the temperature is less than 5 °C (41 °F) or greater than 40 °C (104 °F). Damp basements should also be avoided.

- The maximum calling distance may be shortened when the unit is used in the following places: Near obstacles such as hills, tunnels, undergrounds, near metal objects such as wire fences, etc.
- Operating near 5.8 GHz electrical appliances may cause interference. Move away from the electrical appliances.

Routine care

- Wipe the outer surface of the unit with a soft cloth. Do not use benzine, thinner or any abrasive powder.

Connections

Base unit

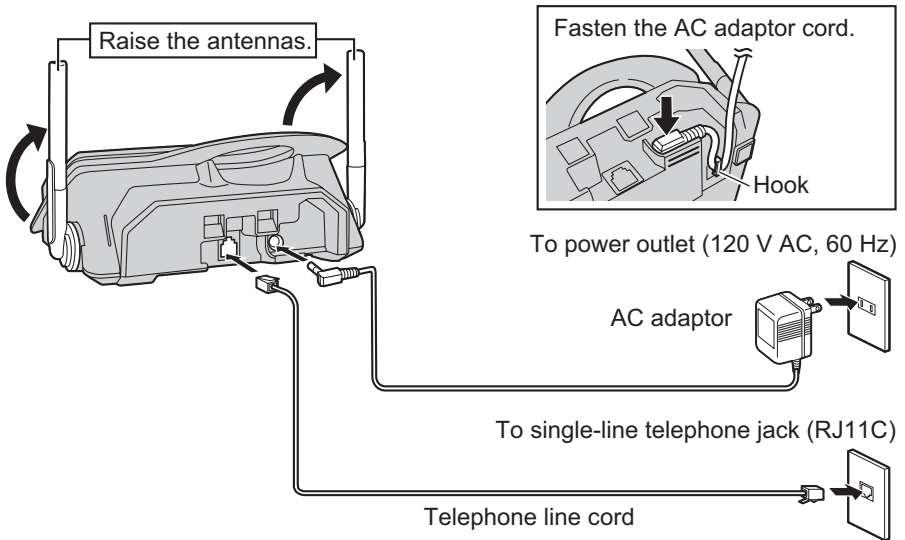

Charger unit (KX-TG5439 only)

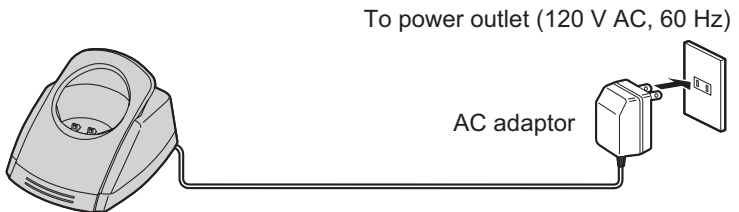

Note:

- Base unit: Use only the included Panasonic AC adaptor PQLV1.
- Charger unit: Use only the included Panasonic AC adaptor KX-TCA1.
- The AC adaptor must remain connected at all times. (It is normal for the adaptor to feel warm during use.)
- The AC adaptor should be connected to a vertically oriented or floor-mounted AC outlet. Do not connect the AC adaptor to a ceiling-mounted AC outlet, as the weight of the adaptor may cause it to become disconnected.
- The unit will not work during a power failure. We recommend connecting a standard telephone to the same telephone line or to the same telephone jack using the Panasonic KX-J66 T-adaptor. Emergency power can be supplied to the unit by connecting a Panasonic battery back-up power supply noted on page 5.

Preparation

If you subscribe to an xDSL service

- Please attach a noise filter (contact your xDSL provider) to the telephone line between the base unit and the telephone line jack in the event of the following:
 - Noise is heard during conversations.
 - Caller ID features (page 26) do not function properly.

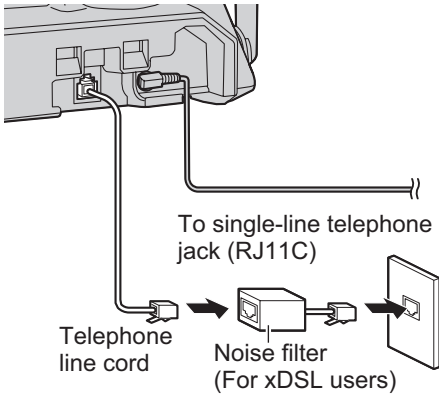

Battery installation

- 1 Release the battery cover latch and slide the cover open.

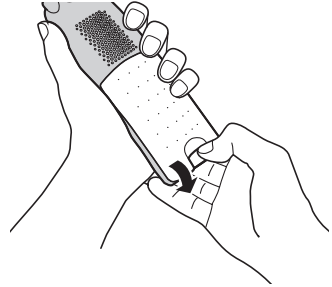

- 2 Insert the battery (①), and press it down until it snaps into the compartment (②).

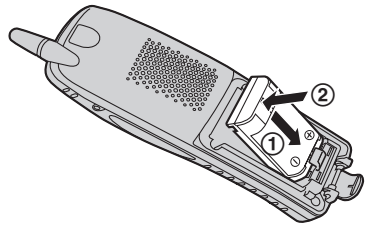

- 3 Close the handset cover.

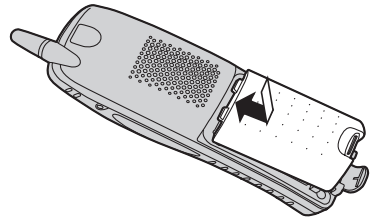

- 4 Fasten the battery cover latch.

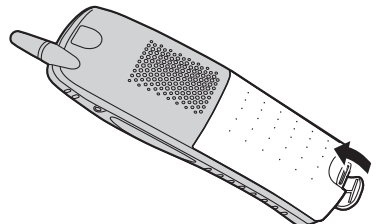

Battery charge

Place the handset on the base unit or charger for **6 hours** before initial use.

- The unit will beep once, the CHARGE indicator will light, and “Charging” will be displayed.
- “Charge completed” is displayed when the battery has been fully charged. The CHARGE indicator will remain lit.

Base unit

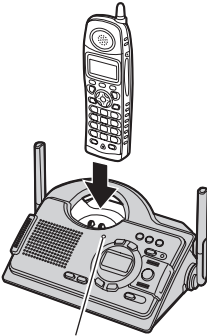

CHARGE indicator

Charger unit (KX-TG5439 only)

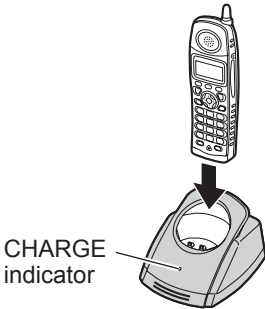

CHARGE indicator

Note:

- To ensure the battery charges properly, clean the charge contacts of the handset, base unit, and charger with a soft, dry cloth once a month. Clean more often if the unit is subject to grease, dust, or high humidity.

Battery strength

You can confirm the battery strength on the handset display.

Battery icon	Battery strength
	Fully charged
	Medium
	Low When flashing: needs to be recharged.
	Discharged

Recharging the battery

Recharge the battery when:

- “Recharge battery” is displayed or flashes on the handset display.
- the handset beeps intermittently while it is in use.

Note:

- Recharge the handset battery for more than 15 minutes, or the display will continue showing the indication.
- If the battery has been discharged, the handset will display “Charge for 6h” and when you place the handset on the base unit or charger.

Preparation

Battery performance

After your Panasonic battery is fully charged, you can expect the following performance:

Operation	Operating time
While in use (talking)	Up to 5 hours
While not in use (standby)* ¹	Up to 11 days
While using the Clarity Booster feature (page 20)	Up to 3 hours



*1 Handset is off the base unit or charger but not in use.

Note:

- Battery power is consumed whenever the handset is off the base unit or charger, even when the handset is not in use. The longer you leave the handset off the base unit or charger, the shorter you can actually talk on the handset. Actual battery performance depends on a combination of how often the handset is in use and how often it is not in use.
- Once the battery is fully charged, you do not have to charge it again until "Recharge battery" is displayed or  flashes. This will maximize the battery life.

Battery replacement

If battery performance diminishes, make sure you have cleaned the charge contacts and fully charged the battery. The battery needs to be replaced if any of the following are displayed after a few phone calls even when you have fully charged the battery.

- "Recharge battery"
-  (flashing)
- "Charge for 6h"
- 

- Use only the rechargeable Panasonic battery noted on page 5.

- 1 Release the battery cover latch and lift the cover open.

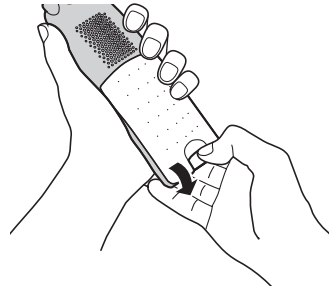

- 2 Replace the old battery with a new one, and close the cover (see page 10 for battery installation).

Attention:



A nickel metal hydride battery that is recyclable powers the product you have purchased.



Please call 1-800-8-BATTERY for information on how to recycle this battery.

Controls and displays

Controls

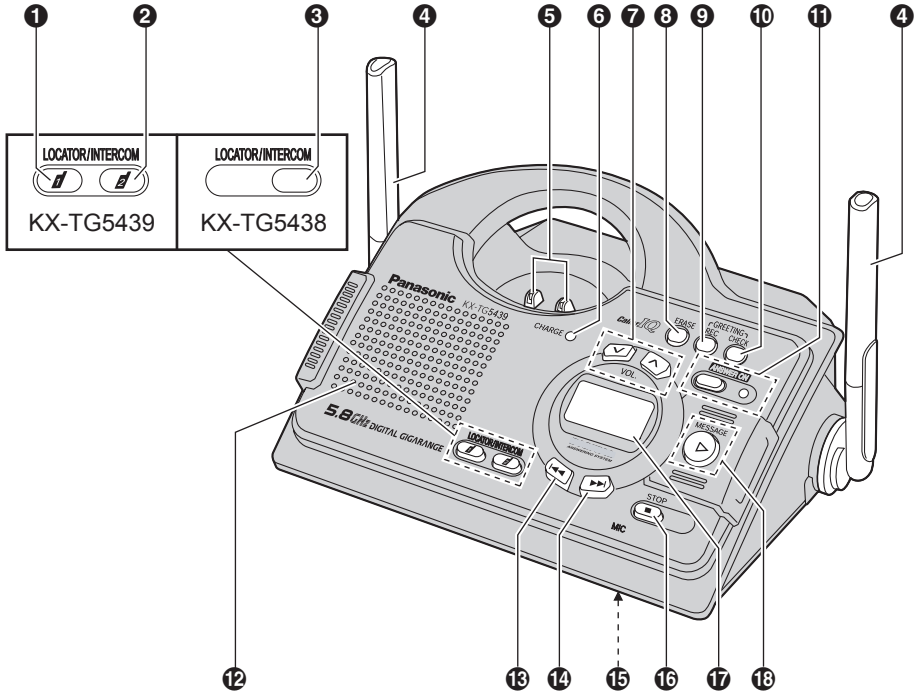
Base unit



- | | |
|---|--------------------------------------|
| ① [LOCATOR/INTERCOM  | ⑪ [ANSWER ON]
ANSWER ON indicator |
| ② [LOCATOR/INTERCOM  | ⑫ Speaker |
| ③ [LOCATOR/INTERCOM] | ⑬ [◀◀] (Repeat) |
| ④ Antenna | ⑭ [▶▶] (Skip) |
| ⑤ Charge contacts | ⑮ MIC (Microphone) |
| ⑥ CHARGE indicator | ⑯ [STOP] |
| ⑦ VOL. (Volume) [V] [^] | ⑰ Display |
| ⑧ [ERASE] | ⑱ [MESSAGE]
MESSAGE indicator |
| ⑨ [GREETING REC] (Recording) | |
| ⑩ [GREETING CHECK] | |

Preparation

Handset

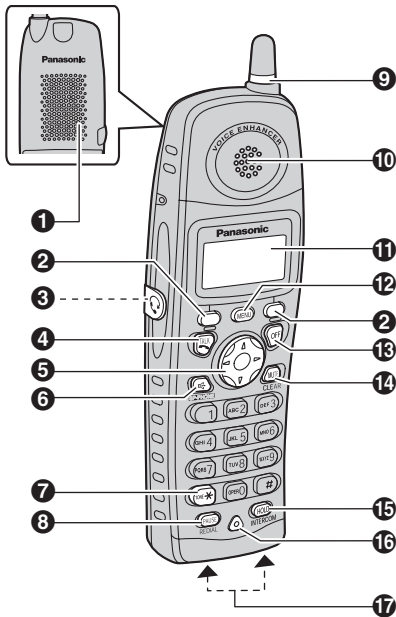

- ❶ Speaker
- ❷ Soft key
- ❸ Headset jack
- ❹ [TALK]
- ❺ Navigator key
- ❻ [SP-PHONE]
- ❼ [*] (TONE)
- ❽ [PAUSE][REDIAL]
- ❾ Ringer indicator
Message indicator
- ❿ Receiver
- ⓫ Display
- ⓬ [MENU]
- ⓭ [OFF]
- ⓮ [MUTE] [CLEAR]
- ⓯ [HOLD] [INTERCOM]
- ⓰ Microphone
- ⓱ Charge contacts

Charger unit (KX-TG5439 only)

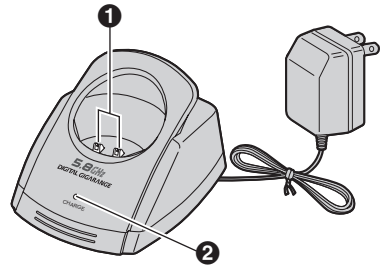

- ❶ Charge contacts
- ❷ CHARGE indicator

Using the navigator key

The handset navigator key can be used to navigate through menus and to select items shown on the display, by pressing [▲], [▼], [◀], or [▶].

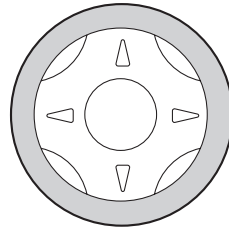

Display

Base unit display items

Displayed item	Meaning
FULL	Flashes when message memory is full.
⌚	Flashes when the date and time need to be set.
IN USE	Base unit is on an intercom call, or handset is using the answering system. When flashing: base unit is paging or is being paged.
LINE IN USE	Line is in use. When flashing: a call is on hold or the answering system is answering a call. When flashing rapidly: a call is being received.
E	Greeting message recording error
g ◻	Answering system is in greeting only mode (caller messages will not be recorded).
H 1	Handset number; displayed when paging or being paged. (example shown here: handset 1) ^{*1}

*1 KX-TG5439 only

Handset display items

Displayed item	Meaning
((VE))	Voice enhancer is on.
 	Battery strength

Soft keys

The handset features 2 soft keys. By pressing a soft key, you can select the function displayed directly above it.

- The functions displayed will vary depending on how you are using the unit.
- When a function does not appear above a soft key, the soft key has no function.

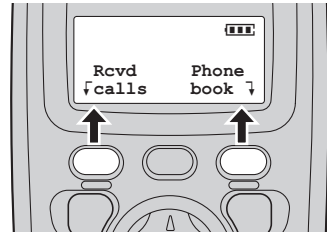

Soft key examples:

Display function	Action
Rcvd calls	Enters caller list
(VX)	Turns voice changer on/off
Conf	Establishes a conference call ^{*1}

*1 KX-TG5439 only

Backlit display and handset keypad

The handset display and dialing buttons will light for a few seconds after pressing any of the handset's controls or lifting the handset off the base unit or charger. They will also light when a call is being received.

Preparation

Setting the date and time

Set the date and time so that the unit will announce the day and time each message was recorded by the answering system (page 43) when you play back messages.

- 1 Press **[MENU]**.
- 2 Scroll to "Date and time" by pressing **[▼]** or **[▲]**, then press **[▶]** or **[Select]**.

```
Date and time
└Back ▼▲ Select┘
```

- 3 Enter the current month, day, and year by selecting 2 digits for each.
Example: June 15, 2005
Press **[0][6] [1][5] [0][5]**.

```
Date:12.31.2005
Time:12:00 AM
└AM/PM Save┘
```

- 4 Enter the current hour and minute (12-hour clock format) by selecting 2 digits for each.
Example: 9:30 PM
Press **[0][9] [3][0]**.

```
Date:06.15.2005
Time:12:00 AM
└AM/PM Save┘
```

- 5 Select "AM" or "PM" by pressing **[AM/PM]**.

```
Date:06.15.2005
Time:09:30 AM
└AM/PM Save┘
```

- 6 Press **[Save]**.
 - When the date and time are set, ☎ disappears from the base unit display.
 - If the handset beeps 3 times, the date and time were not set correctly. Enter the correct digits.

- 7 Press **[OFF]**.

Note:

- If you make a mistake when entering the date and time, press **[◀]**, **[▶]**, **[▼]**, or **[▲]** to move the cursor, then make the correction.
- If a power failure occurs, ☎ will flash to indicate the date and time must be set again.

To confirm the date and time

Repeat steps 1 and 2. Press **[OFF]** when finished.

Time adjustment (Caller ID subscribers only)

When calls are received, Caller ID will automatically adjust the date and time (including daylight saving time).

- If you have not set the date and time manually, Caller ID will not adjust the date and time.
- You can turn this feature off (page 40).

Making calls

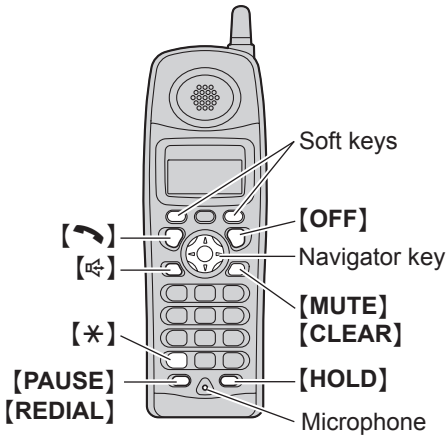

- 1 Lift the handset and press [↶].
 - "Talk" will be displayed.
- 2 Dial the phone number.
- 3 When finished talking, press [OFF] or place the handset on the base unit or charger.

Note:

- "Line in use" is displayed when someone is talking on the other handset (KX-TG5439 only) or another phone.

To adjust the receiver volume

3 levels (high/medium/low) are available. While using the receiver, press [▼] or [▲] repeatedly.

To use the speakerphone

- 1 Lift the handset and press [📞].
 - "SP-phone" will be displayed.
- 2 Dial the phone number.
- 3 When the other party answers, speak into the microphone.

- 4 When finished talking, press [OFF] or place the handset on the base unit or charger.

Note:

- Talk alternately with the caller in a quiet room.
- If the other party has difficulty hearing you, press [▼] to decrease the speaker volume.
- While on a call, you can switch from the receiver to the speakerphone by pressing [📞]. To switch back to the receiver, press [↶].

To adjust the speaker volume

6 levels (high to low) are available. While using the speaker, press [▼] or [▲] repeatedly.

To dial after confirming the entered number

- 1 Enter the phone number.

Example:



- To correct a digit, press [◀] or [▶] to move the cursor, then press [CLEAR]. Enter the correct number.
 - If a pause is required when dialing, press [PAUSE] where needed (page 21).
 - To cancel, press [OFF].
- 2 Press [↶], [📞], or [Call].
 - 3 When finished talking, press [OFF] or place the handset on the base unit or charger.

To redial the last number dialed

- 1 Press [↶] or [📞].
- 2 Press [REDIAL].

Making/Answering Calls

To make a call using the redial list

The last 5 phone numbers dialed are stored in the redial list.

- 1 Press **[REDIAL]**.
 - The last number dialed will be displayed.
- 2 Press **[▼]** or **[▲]** repeatedly to display the desired number.
 - To delete the displayed number, press **[CLEAR]**.
 - To exit the list, press **[OFF]**.
- 3 Press **[↶]**, **[↷]**, or **[Call]**.

Answering calls

When a call is being received, the ringer indicator flashes rapidly.

- 1 Lift the handset and press **[↶]** or **[↷]**.
 - You can also answer a call by pressing any button except **[▼]**, **[▲]**, **[←]**, **[→]**, or **[OFF]**. (**Any key talk feature**)
- 2 When finished talking, press **[OFF]** or place the handset on the base unit or charger.

Auto talk

This feature allows you to answer a call by simply lifting the handset off the base unit or charger. You do not need to press **[↶]**. To activate this feature, see page 36.

Temporary ringer off

While the handset is ringing for an outside call, you can turn the ringer off temporarily by pressing **[OFF]**. The handset will ring the next time a call is received.

Useful features during a call

Voice changer

This feature allows you to modify the sound of your voice heard by the other party. Different voice changer types are available.

Important:

- We recommend selecting the desired voice changer type beforehand (page 36).

To turn this feature on, press **[(VX)]** after pressing **[↶]** or **[↷]**.

Example:

Talk
00-00-20
↓Flash (VX) ↓

- When turned on, “(vx)” will flash on the display and your voice will be modified to the outside party according to the voice changer type selected.
- You can change the voice changer type by pressing **[◀]** or **[▶]**.
- To turn this feature off, press **[(VX)]** again.

Note:

- This feature will turn off when you hang up, put a call on hold, or answer another call with Call Waiting (page 21).

HOLD button

This feature allows you to put an outside call on hold.

KX-TG5438:

Press **[HOLD]** during an outside call.

- “Ho1d” will be displayed.
- To return to the call, press **[↶]** or **[↷]**.

KX-TG5439:

1 Press **[HOLD]** during an outside call.

- To transfer the call to the other handset, see page 32, step 2.

2 Press **[HOLD]** again.

- “Ho1d” will be displayed.
- To return to the call, press **[↶]** or **[↷]**.
- The other handset user can take the call by pressing **[↶]** or **[↷]**.

Note:

- “Line on hold” will be displayed on the other handset (KX-TG5439 only).
- If another phone is connected on the same line (page 9), you can also take the call by lifting its handset.
- If a call is kept on hold for more than 6 minutes, an alarm tone will start to sound and the ringer indicator will flash rapidly. After 4 additional minutes on hold, the call will be disconnected.

MUTE button

You can mute your voice during a conversation. While mute is turned on you will be able to hear the other party, but the other party will not be able to hear you.

To mute your voice, press **[MUTE]**.

Example:

Talk
00-00-30 <Mute>

- “<Mute>” will flash on the display.
- To return to the conversation, press **[MUTE]**, **[↶]**, or **[↷]**.

Voice enhancer

This feature clarifies the voice of the person you are talking to, reproducing a more natural-sounding voice that is easier to hear and understand.

- 1 Press **[MENU]** during an outside call.
- 2 To turn this feature on or off, press **[3]**.
 - You can also select “**V.E. on**” or “**V.E. off**” by pressing **[▼]** or **[▲]** then pressing **[▶]**.

▶3=V.E. on 4=Caller IQ

- When turned on, “**(VE)**” will be displayed.

Note:

- Once you turn voice enhancer on, it will be activated for all outside calls until turned off.
- You can also turn this feature on or off by programming (page 37).
- Depending on the condition and quality of your telephone line, this feature may emphasize existing line noise. If it becomes difficult to hear, turn this feature off.

Clarity booster

This feature can improve sound clarity when the handset is used in an area where there may be interference. During an outside call, this feature will be turned on automatically when necessary. This feature will turn off when you hang up or put a call on hold. It will not turn off automatically during a call. You can also turn this feature on or off manually.

- 1 Press **[MENU]** during an outside call.
- 2 Press **[2]** to select “**Booster on**” or “**Booster off**”.

- You can also select “**Booster on**” or “**Booster off**” by pressing **[▼]** or **[▲]** then pressing **[▶]**.

1=Phonebook ▶2=Booster on

- While this feature is turned on, “**BOOST**” will flash on the display.

Note:

- If this feature is turned off manually during a call, it will not be turned on automatically during the same call.
- While this feature is turned on, battery operating time will be shortened (page 12).

Call share (KX-TG5439 only)

When the other handset is on an outside call, this feature allows you to join that call. To join a conversation, press **[📞]** or **[📞]** when the other handset is on an outside call.

- “**Conference**” will be displayed.

PAUSE button (for PBX/long distance service users)

A pause is sometimes required when making calls using a PBX or long distance service.

For example, if you need to dial the line access number "9" when making outside calls with a PBX:

- 1 Press **[9]**.
- 2 Press **[PAUSE]**, then dial the phone number.

Example:

9P15556667777
↓Flash Call↓

- 3 Press **[↶]**, **[☎]**, or **[Call]**.

Note:

- A 3.5 second pause is inserted each time **[PAUSE]** is pressed. Press repeatedly to insert longer pauses.

Flash button

Pressing **[Flash]** allows you to use special features of your host PBX such as transferring an extension call, or accessing optional telephone services such as Call Waiting.

Example:

Talk
00-00-20
↓Flash (VX) ↓

Note:

- To change the flash time, see page 38.

For Call Waiting service users

To use Call Waiting, you must subscribe to your telephone company's Call Waiting service.

This feature allows you to receive calls while you are already talking on the phone. If you receive a call while on the phone, you will hear a Call Waiting tone.

Press **[Flash]** to answer the 2nd call.

- The 1st call is put on hold while you answer the 2nd call.
- To switch between calls, press **[Flash]**.

Note:

- Please contact your telephone company for details and availability of this service in your area.

Temporary tone dialing (for rotary/pulse service users)

You can temporarily switch the dialing mode to tone when you need to access touch tone services (for example, answering services, telephone banking services, etc.).

Press **[*]** (TONE) before entering access numbers which require tone dialing.

Note:

- The dialing mode will return to pulse when you hang up.

Using the phonebook

The handset phonebook allows you to make calls without having to dial manually. You can add 50 names and phone numbers to the handset phonebook and search for phonebook entries by name.

Adding items to the phonebook

1 Press **[Phonebook]**.

Rcvd ↓calls	Phone book ↓
----------------	-----------------

2 Press **[Add]**.

- The display shows the number of items in the phonebook.

Example:

Phonebook 7 items
↓Add Search↓

3 Enter the name (max. 16 characters).
See the character table for entry.

Enter name
↓Back Next↓

4 Press **[Next]**.

5 Enter the phone number (max. 32 digits).

- If a pause is required when dialing, press **[PAUSE]** where needed (page 21).

Enter phone no.

6 Press **[Next]**.

- If you want to change the name and number, press **[Edit]**, then repeat from step 3.

Example:

Tom 555-765-4321
↓Edit Save↓

7 Press **[Save]**.

- To add other items, repeat from step 2.

8 Press **[OFF]**.

Note:

- Caller ID subscribers can use ringer ID and light-up ID features (page 26).

Character table

The dial keys can be used to enter characters. To enter a character, press the appropriate dial key, repeatedly if necessary. To enter another character that is located on the same dial key, first press **[▶]** to move the cursor to the next space.

Key	Characters
[1]	& ' () , - . / 1
[2]	a b c A B C 2
[3]	d e f D E F 3
[4]	g h i G H I 4
[5]	j k l J K L 5
[6]	m n o M N O 6
[7]	p q r s P Q R S 7
[8]	t u v T U V 8
[9]	w x y z W X Y Z 9
[0]	0 Space
[*]	*
[#]	#
[CLEAR]	To delete a character or number

To edit/correct a mistake

Press **[◀]** or **[▶]** to move the cursor to the character or number you wish to erase, then press **[CLEAR]**. Enter the appropriate character or number.

Note:

- Press and hold **[CLEAR]** to erase all characters or numbers.

Calling someone in the phonebook

Phonebook items can be searched for alphabetically by scrolling through the phonebook items.

- 1 Press **[Phonebook]**.
 - For quick search, you can skip to step 3.

- 2 Press **[Search]**.

0-9=Name search
▼▲=Scroll list

- 3 Press **[▼]** or **[▲]** repeatedly to display the desired item.
 - To exit the phonebook, press **[OFF]**.

- 4 Press **[↶]** or **[↷]**.

Note:

- To view a phone number over 16 digits long, follow steps 1 to 3, then press **[Edit]** and **[Next]**. Press **[OFF]** when finished.

To search for a name by initial

- 1 Press **[Phonebook]**, then press **[Search]**.
- 2 Press the dialing button (**[0]** to **[9]**, **[#]**, or **[*]**) which corresponds to the first letter you are searching for (see the character table, page 22).
Example: "LISA"
Press **[5]** repeatedly to display any name with the initial "L".
 - If there is no item corresponding to the letter you selected, the next item will be displayed.
- 3 Press **[▼]** repeatedly to display the desired item.
 - To exit the phonebook, press **[OFF]**.
 - To dial the displayed number, press **[↶]** or **[↷]**.

Editing items in the phonebook

- 1 Press **[Phonebook]**, then press **[Search]**.
- 2 Press **[▼]** or **[▲]** repeatedly to display the desired item.
- 3 Press **[Edit]**.
- 4 Edit the name if necessary. See the character table on page 22 for character entry.
- 5 Press **[Next]**.
- 6 Edit the phone number if necessary.
- 7 Press **[Next]**, then press **[Save]**.
 - To edit other items, repeat from step 2.
- 8 Press **[OFF]**.

Erasing items in the phonebook

- 1 Press **[Phonebook]**, then press **[Search]**.
- 2 Press **[▼]** or **[▲]** repeatedly to display the desired item.
- 3 Press **[CLEAR]**.
- 4 Press **[Yes]**.
 - To cancel erasing, press **[No]**.
 - To erase other items, repeat from step 2.
- 5 Press **[OFF]**.

Chain dial feature

This feature allows you to dial phone numbers from the phonebook while you are on a call.

Example: Using a long distance calling card

- ① Dial from the phonebook:
1-800-012-3456 (Calling card access number).
- ② When prompted, dial from the phonebook:
1234 (Calling card PIN).
- ③ When prompted, dial from the phonebook:
1-555-012-3456 (the person you want to call).

1 During an outside call, press **[MENU]**.

2 Press **[1]** to select "Phonebook".

3 Press **[▼]** or **[▲]** repeatedly to display the desired item.

4 Press **[Call]**.

- Repeat from step 1 to dial other numbers.

Note:

- When storing a calling card access number and your PIN in the phonebook as one phonebook item, press **[PAUSE]** to add pauses after the number and PIN as necessary (page 21).
- If you have rotary or pulse service, you need to press **[*]** before pressing **[MENU]** in step 1 to change the dialing mode temporarily to tone.

Copying phonebook items (KX-TG5439 only)

You can copy one or all of the phonebook items of one handset to the phonebook of the other handset.

Important:

- Make sure the destination handset is not in use.
- Do not place your handset on the base unit or charger until copying has finished, otherwise copying will stop.
- If an outside call is received during the phonebook copy, copying will stop. You will need to copy the item(s) later.
- Ringer ID and light-up ID settings for phonebook items are not copied (page 26).

Copying an item

1 Press **[MENU]**.

2 Scroll to "Copy phonebook" by pressing **[▼]** or **[▲]**, then press **[▶]**.

3 Scroll to "Copy 1 item" by pressing **[▼]** or **[▲]**, then press **[▶]**.

4 Press **[▼]** or **[▲]** repeatedly to display the desired item.

- To search for the item by initial, see page 23.

5 Press **[Send]**.

- When the item has been copied, "Complete" will be displayed.
- The destination handset display will show "Phonebook Receiving", then "Phonebook Received".
- To copy another item, repeat from step 4.

6 Press **[OFF]**.

Copying all items

- 1** Press **[MENU]**.
- 2** Scroll to “Copy phonebook” by pressing **[▼]** or **[▲]**, then press **[▶]**.
- 3** Scroll to “Copy all items” by pressing **[▼]** or **[▲]**, then press **[▶]**.
 - When all items have been copied, “Complete” will be displayed.
 - The destination handset display will show “Phonebook Receiving”, then “Phonebook Received”.
- 4** Press **[OFF]**.

Using Caller ID service

This unit is Caller ID compatible. To use Caller ID features, you must subscribe to your telephone company's Caller ID service.

Caller ID features

When an outside call is being received, the calling party's name or telephone number will be displayed.

Caller information for the last 50 different callers will be logged in the caller list, allowing you to return missed calls. Caller information is stored by the most recent call to the oldest.

- When Caller ID information is received and it matches a phone number stored in the phonebook:
 - The stored name will be displayed and logged in the caller list. (**Personalized name display**)
 - The handset will use the ringer tone and the ringer indicator color you assigned to the caller. (**Ringer ID and light-up ID**)
- While listening to a message recorded by the answering system, using the handset, you can call back the caller without having to dial the phone number (page 47).
- If the unit cannot receive caller information, the following will be displayed:
 - “**Out of area**”: The caller dialed from an area which does not provide Caller ID service.
 - “**Private caller**”: The caller requested not to send caller information.
 - “**Long distance**”: The caller called you long distance.
- If the unit is connected to a PBX system, caller information may not be received properly. Consult your PBX supplier.

Call Waiting Caller ID display

If you subscribe to both Caller ID and Call Waiting with Caller ID services, the 2nd caller's information will be displayed after you hear a Call Waiting tone (page 21).

Example:

BROWN, NANCY
1-555-666-7777
√Flash -Waiting-

Note:

- Please contact your telephone company for details and availability of this service in your area.

Ringer ID and light-up ID

This feature can help you identify who is calling by using different ringers and ringer indicator colors for different callers stored in the phonebook. You can assign a different ringer and indicator color to each phonebook item. When a call is received from a caller stored in the phonebook, the ringer and indicator color are used after Caller ID information is displayed.

- Usually the ringer and indicator color will be changed from the 2nd ring.

Ringer ID

You can assign a different ringer tone to each caller in the phonebook. If you select “**No Ringer ID**”, the unit will use the ringer tone you set on page 35 when a call is received from that caller. The default setting is “**No Ringer ID**”.

- 1 Press [**Phonebook**], then press [**Search**].
- 2 Press [**▼**] or [**▲**] repeatedly to display the desired item.
- 3 Press [**Option**].
- 4 Press [**1**] to select “**Ringer ID**”.
- 5 Press [**▼**] or [**▲**] repeatedly to select the desired ringer tone.

- You can also select the ringer tone by pressing **[1]** to **[7]**, or **[0]** ("No Ringer ID").

6 Press **[Save]**, then press **[OFF]**.

Light-up ID

You can assign a different ringer indicator color to each caller in the phonebook. Select "Color1-Default" (Amber), "Color2" (Green), "Color3" (Red), or "Multicolor".

- Press **[Phonebook]**, then press **[Search]**.
- Press **[v]** or **[^]** repeatedly to display the desired item.
- Press **[Option]**.
- Press **[2]** to select "Light-up ID".
- Press **[v]** or **[^]** repeatedly to select the desired ringer indicator color.
 - You can also select the color by pressing **[1]** to **[4]**.
- Press **[Save]**, then press **[OFF]**.

Caller list

Caller information for the last 50 different callers will be logged in the caller list. You can use this list to return missed calls.

- Caller information includes caller names and phone numbers, the date and time of calls, and the number of times the caller called.

Missed calls

If a call is not answered, the unit treats the call as a missed call. The number of missed calls is shown on the handset display. This lets you know if you should view the caller list to see who called while you were out.

Example: Handset off the base unit or charger

10 missed calls	
Rcvd	Phone
↓calls	book ↓

Note:

- When the unit has new messages, "New message" will be displayed in place of "missed calls".

Viewing the caller list and calling back

- Press **[v]** or **[^]** to enter the caller list.
- Press **[v]** to search from the most recent call, or press **[^]** to search from the oldest call.
 - The caller's name and phone number are displayed alternately.

Example:

SMITH, JACK 3:10P JUN.29
↑
1-555-333-4444 3:10P JUN.29

- To exit the caller list, press **[OFF]**.

3 Press **[↶]** or **[☎]**.

Caller ID Service

Note:

- You can also press [**Rcvd calls**] to enter the caller list.
- Calling back will not be possible if the caller information does not include a phone number.
- In some cases, you may have to edit the number before dialing. (For example, you may have to delete “1” and the area code.)
- KX-TG5439 only:
Each handset has its own caller list. If you viewed the caller list or answered a call on one handset, the same information in the other handset will be displayed as “**missed calls**”.

Displayed symbols

- If the same caller calls more than once, it will be displayed with the number (“x2” to “x9”). Only the date and time of the most recent call will be stored.
- A ✓ is displayed next to items which have already been viewed or answered on this handset.

Editing a caller’s phone number before calling back

You can edit a phone number in the caller list by removing its area code and/or the long distance code “1”.

- 1 Press [**▼**] or [**▲**] to enter the caller list.
- 2 Press [**▼**] or [**▲**] repeatedly to display the desired item.
- 3 Press [**Edit**] repeatedly until the phone number is shown in the desired format. Each time you press [**Edit**], the phone number will be rearranged into one of 3 patterns.

- ① Local phone number

Example:

- ② Area code – Local phone number

Example:

- ③ 1 – Area code – Local phone number

Example:

- 4 To return a call, press [**↶**] or [**☎**].

Caller ID number auto edit feature

Once you call back an edited number (see “Editing a caller’s phone number before calling back”), the unit can automatically edit other incoming phone numbers each time you receive a call.

For example, you can use this feature to set the unit to ignore the area code of callers in your area code, so that you can call these local numbers using caller information without dialing the area code. To activate this feature, you must edit an item in the caller list (see “Editing a caller’s phone number before calling back”), then call that number. After that, calls from that caller’s area code will be edited automatically.

This feature can be turned on or off (page 37). The default setting is ON.

Note:

- The handset can remember up to 4 area codes to be edited. Phone numbers from the 4 most recently edited area codes will be automatically edited.
- This feature will not be activated until edited numbers are called back.
- If you move to another area, you can turn this feature off to erase previously edited area codes. To use this feature again, turn it on and reprogram the area codes you want to edit once again.

Storing caller information into the phonebook

Items in the caller list can be stored into each handset's phonebook.

- 1 Press [**▼**] or [**▲**] to enter the caller list.
- 2 Press [**▼**] or [**▲**] repeatedly to display the desired item.
 - To edit the number, press [**Edit**] repeatedly until the number is shown in the desired format (page 28, step 3).
- 3 Press [**Save**].
 - If there is no name information for the caller, "Enter name" will be displayed.
 - ① Enter the name if necessary (see page 22, step 3).
 - ② Press [**Next**], then press [**Save**].
 - To continue storing other items, repeat from step 2.
- 4 Press [**OFF**] to exit.

Note:

- If the caller information does not include a phone number, you cannot store it in the phonebook.

Erasing caller information

Erasing a selected item

- 1 Press [**▼**] or [**▲**] to enter the caller list.
- 2 Press [**▼**] or [**▲**] repeatedly to display the desired item.
- 3 Press [**CLEAR**].
 - To erase other items, repeat from step 2.
 - To exit the caller list, press [**OFF**].

Erasing all items

Make sure that you have no missed calls.

- 1 Press [**▼**] or [**▲**] to enter the caller list.
- 2 Press [**All erase**].
 - To cancel erasing, press [**No**].
- 3 Press [**Yes**].

Intercom

Intercom calls can be made between a handset and the base unit (and between 2 handsets, KX-TG5439 only).

Note:

- If you have difficulty hearing the other party while using the speaker, decrease the speaker volume.
- If you receive a phone call while talking on the intercom, you will hear 2 tones (page 35). To answer the call, press **[OFF]**, then press **[↶]** or **[↷]**.
- You cannot change the ringer tone for intercom calls.

For KX-TG5438 users

From the handset to the base unit

1 Handset:

Press **[INTERCOM]**.

- The base unit will beep for 1 minute.
- To stop paging, press **[OFF]**.

2 Base unit:

Press **[LOCATOR/INTERCOM]** to answer the page.

3 Handset:

When finished talking, press **[OFF]**.

Note:

- During an intercom call, the handset user can switch to the speaker by pressing **[↷]**. To switch back to the receiver, press **[↶]**.
- To adjust the base unit's speaker volume, press **[^]** or **[v]** repeatedly. 8 levels (high to low) are available.

From the base unit to the handset

1 Base unit:

Press **[LOCATOR/INTERCOM]**.

- The handset will beep for 1 minute.
- To stop paging, press **[LOCATOR/INTERCOM]**.

2 Handset:

Press **[↶]**, **[↷]**, or **[INTERCOM]** to answer the page.

3 Base unit:

When the paged party answers, speak into the MIC.

4 Base unit:

When finished talking, press **[LOCATOR/INTERCOM]**.

Note:

- You can locate a misplaced handset by paging it. (**Handset locator**)

For KX-TG5439 users

Call the desired unit by selecting the extension number, shown in the upper right of each handset's display. The base unit's extension number is 0.

- To confirm the handset's extension number ([1] or [2]), place the handset on the base unit or charger.
- The base unit will display the paging or paged handset number (H 1 or H 2).

From the handset to the base unit

1 Handset:

Press **[INTERCOM]**, then press **[0]**.

- You can also select the base unit by pressing **[▼]** or **[▲]** then pressing **[▶]**.
- The base unit will ring for 1 minute.
- To stop paging, press **[OFF]**.

2 Base unit:

Press either **[LOCATOR/INTERCOM 1]** or **[LOCATOR/INTERCOM 2]** to answer the page.

3 Handset:

When finished talking, press **[OFF]** or place the handset on the charger.

Note:

- During an intercom call, the handset user can switch to the speaker by pressing **[☎]**. To switch back to the receiver, press **[📞]**.
- To adjust the base unit's speaker volume, press **[^]** or **[v]** repeatedly. 8 levels (high to low) are available.

From the base unit to a handset

1 Base unit:

Press **[LOCATOR/INTERCOM 1]** or **[LOCATOR/INTERCOM 2]**.

- The handset will beep for 1 minute.
- To stop paging, press either **[LOCATOR/INTERCOM 1]** or **[LOCATOR/INTERCOM 2]**.

2 Handset:

Press **[📞]**, **[☎]**, or **[INTERCOM]** to answer the page.

3 Base unit:

When the paged party answers, speak into the MIC.

4 Base unit:

When finished talking, press either **[LOCATOR/INTERCOM 1]** or **[LOCATOR/INTERCOM 2]**.

Note:

- You can locate a misplaced handset by paging it. (**Handset locator**)

From one handset to the other handset

Example: When handset 1 calls handset 2.

1 Handset 1:

Press **[INTERCOM]**, then press the other handset number **[2]**.

- You can also select the handset by pressing **[▼]** or **[▲]** then pressing **[▶]**.
- The paged handset will beep for 1 minute.
- To stop paging, press **[OFF]**.

2 Handset 2:

Press **[📞]**, **[☎]**, or **[INTERCOM]** to answer.

- #### 3
- When finished talking, press **[OFF]** or place the handset on the base unit or charger.

Transferring a call (KX-TG5439 only)

Outside calls can be transferred from one handset to the other.

- 1 During an outside call, press **[INTERCOM]**.
 - The call will be put on hold.
- 2 To page the other handset, press **[handset[1]]** or **[handset[2]]**.
- 3 Wait for the paged party to answer.
 - The paged handset user can answer by pressing **[↶]**, **[↷]**, or **[INTERCOM]**.
 - If there is no answer, press **[↶]** or **[↷]** to return to the outside call.
- 4 To complete the transfer, press **[OFF]**.

Transferring a call without speaking to the paged party

- 1 During an outside call, press **[INTERCOM]**, then press **[handset[1]]** or **[handset[2]]**.
- 2 Press **[OFF]**.
 - The outside call rings at the other handset.

Note:

- If the paged party does not answer the call, press **[↶]** or **[↷]** to return to the call. If not answered within 1 minute, the call will ring at your handset again. If you still do not answer the call within 4 minutes, the call will be disconnected.

Conference calls (KX-TG5439 only)

A conference call allows 2 handsets to speak together with an outside party.

- 1 During an outside call, press **[INTERCOM]**.
 - The call will be put on hold.
- 2 To page the other handset, press **[handset[1]]** or **[handset[2]]**.
- 3 When the paged party answers, press **[Conf]** on your handset to establish a conference call.
 - "conference" will be displayed.
 - To leave the conference, press **[OFF]**. The other 2 parties can continue the conversation.

Note:

- The outside call can be put on hold by pressing **[HOLD]** during a conference call. Communications between extensions are not suspended. Only the person who placed the call on hold can resume the conference by pressing **[Conf]**.

Guide to handset programming

For your reference, a chart of all programmable functions is printed below. Details for each item can be found on the corresponding pages. To program, press **[MENU]**, press **[▼]** or **[▲]** to scroll through the menu, and press **[▶]** or **[Select]** when the desired menu item or setting is displayed.

Important:

- Before programming, make sure the handset and base unit are not being used. The handset must be operated near the base unit and while off the base unit or charger.

Main menu	Sub-menu 1	Sub-menu 2	Page
Message play	–	–	page 46
Ringer setting	Ringer volume	–	page 34
	Ringer tone	–	page 35
	Interrupt tone	–	page 35
Date and time ^{*3}	–	–	page 16
VoiceChanger[VX]	–	–	page 36
Voice enhancer	–	–	page 37
Caller IQ ^{*1}	View Info.? ^{*2}	–	–
	Get new Info.?	–	–
	Turn CIQ off?	–	–
Copy phonebook ^{*4}	Copy 1 item	–	page 24
	Copy all items	–	page 25
Customer support	–	–	page 40
Initial setting	Set answering	Ring count ^{*3}	page 50
		Recording time ^{*3}	page 50
		Remote code ^{*3}	page 49
	Message alert	–	page 51
	LCD contrast	–	page 37
	Key tone	–	page 39
	Auto talk	–	page 36
	Caller ID edit	–	page 37
	Time adjustment ^{*3}	–	page 40
	Set tel line	Set dial mode ^{*3}	page 38
		Set flash time ^{*3}	page 38
		Set line mode ^{*3}	page 38
	Registration	–	page 39
Change language	–	page 37	

Programmable Settings

- *1 Can be used to activate Caller IQ. See the leaflet included with this unit for more information.
- *2 “**Activate CIQ?**” is displayed if you have not subscribed to openLCR service. “**Turn CIQ on?**” is displayed when Caller IQ is turned off. See the leaflet included with this unit for more information.
- *3 If you program these settings using one of the handsets, you will not need to program the same item using the other handset (KX-TG5439 only).
- *4 KX-TG5439 only

Note:

- To exit programming, press **[OFF]** at any time.
- To go back to the previous menu, press **[◀]** or **[Back]**, or press **[▶]** or **[Select]** while “(Go back)” is displayed.

Ringer settings

Handset ringer volume

4 levels (high/medium/low/off) are available. The default setting is HIGH.

- 1 Press **[MENU]**.
- 2 Scroll to “**Ringer setting**” by pressing **[▼]** or **[▲]**, then press **[▶]**.

Ringer setting

- 3 Scroll to “**Ringer volume**” by pressing **[▼]** or **[▲]**, then press **[▶]**.

Ringer volume

- 4 Press **[▼]** or **[▲]** repeatedly to select the desired volume.

Ringer volume
Low ■■■■■ High
↓Back ▼▲ Save↓

- To turn the ringer off, press **[▼]** repeatedly until “**off ?**” is displayed.

- 5 Press **[Save]**.

Note:

- When the ringer volume is set to off, the handset will display “**Ringer off**”, and will not ring for outside calls. The handset will ring at the low level for intercom calls.

Handset ringer tone

You can change the ringer tone heard when an outside call is received. There are 3 tones and 4 melodies. The default setting is "Tone 1".

- 1 Press **[MENU]**.
- 2 Scroll to "Ringer setting" by pressing **[▼]** or **[▲]**, then press **[▶]**.

Ringer setting

- 3 Scroll to "Ringer tone" by pressing **[▼]** or **[▲]**, then press **[▶]**.

Ringer tone

- 4 Press **[▼]** or **[▲]** repeatedly to select the desired setting.

Ringer tone
1=Tone 1
↓Back ▼▲ Save↓

- You can also select the ringer tone by pressing **[1]** to **[7]**.
- If the ringer volume has been turned off, the handset will not ring.

- 5 Press **[Save]**, then press **[OFF]**.

Note:

- If you subscribe to a distinctive ring service (such as IDENTA-RING), select a tone (Tone 1 to 3). If you select a melody, you will not be able to distinguish lines by their ringers.
- If you select one of the melody ringer patterns, the ringer will continue to sound for several seconds if:
 - the caller hangs up before you answer the call.
 - another person answers the call using another phone connected on the same line.

Handset interrupt tone

This tone lets you know when you receive a call while you are on an intercom call (page 30).

- "2" (default): The tone will sound 2 times.
- "on": The tone will sound for as long as the line rings.
- "off": Turns this feature off.

- 1 Press **[MENU]**.
- 2 Scroll to "Ringer setting" by pressing **[▼]** or **[▲]**, then press **[▶]**.
- 3 Scroll to "Interrupt tone" by pressing **[▼]** or **[▲]**, then press **[▶]**.
- 4 Press **[▼]** or **[▲]** repeatedly to select the desired setting.
- 5 Press **[Save]**, then press **[OFF]**.

Call options

Auto talk

When this feature is turned on, you can answer a call by lifting the handset off the base unit or charger without pressing [↵]. The default setting is OFF.

- 1 Press [MENU].
- 2 Scroll to "Initial setting" by pressing [▼] or [▲], then press [▶].
- 3 Scroll to "Auto talk" by pressing [▼] or [▲], then press [▶].
- 4 Press [▼] or [▲] repeatedly to select the desired setting.
- 5 Press [Save], then press [OFF].

Note:

- If you subscribe to Caller ID service and want to view the caller's information on the handset display after lifting up the handset to answer a call, turn off this feature.

Voice changer

This feature allows you to modify the sound of your voice heard by the other party.

You can select a different voice changer type for phone conversations ("Talk" mode) and for the answering system greeting message ("Greeting" mode). The "Talk" setting will be used when you turn on the voice changer while on a call (page 19). The "Greeting" setting will be used when your greeting message is played for callers by the answering system.

"Deep Voice": Low-pitch voice

"High Voice": High-pitch voice

"Fun Voice": Electronic sounding voice

"Off" ("Greeting" mode only):

Unmodified voice

The default setting for "Talk" mode is "Deep Voice", and for "Greeting" mode is "Off".

- 1 Press [MENU].
 - 2 Scroll to "VoiceChanger [VX]" by pressing [▼] or [▲], then press [▶].
 - 3 To select "Talk", press [1]. Press [▼] or [▲] repeatedly to select the desired setting.
 - You can sample the selected voice changer type by speaking into the handset. Your voice will be heard through the base unit speaker.
- OR
- To select "Greeting", press [2]. Press [▼] or [▲] repeatedly to select the desired setting.
- Your greeting message will be heard through the base unit speaker.
 - To turn this feature off, press [0].
- 4 Press [Save], then press [OFF].

Note:

- In step 3, you can also select the voice type by pressing [1] to [3].
- To adjust the base unit's speaker volume, press [Λ] or [V] repeatedly on the base unit.

Voice enhancer

You can turn the voice enhancer feature on or off. The default setting is OFF.

- 1** Press **[MENU]**.
- 2** Scroll to “**voice enhancer**” by pressing **[▼]** or **[▲]**, then press **[▶]**.
- 3** Press **[▼]** or **[▲]** repeatedly to select “**On**” or “**Off**”.
- 4** Press **[Save]**, then press **[OFF]**.
 - When turned on, “**(VE)**” will be displayed.

Caller ID edit

You can turn the Caller ID number auto edit feature (page 28) on or off. The default setting is ON.

- 1** Press **[MENU]**.
- 2** Scroll to “**Initial setting**” by pressing **[▼]** or **[▲]**, then press **[▶]**.
- 3** Scroll to “**Caller ID edit**” by pressing **[▼]** or **[▲]**, then press **[▶]**.
- 4** Press **[▼]** or **[▲]** repeatedly to select “**On**” or “**Off**”.
- 5** Press **[Save]**, then press **[OFF]**.

Display options

Handset LCD contrast

You can adjust the handset display contrast. There are 6 levels. The default setting is level 3.

- 1** Press **[MENU]**.
- 2** Scroll to “**Initial setting**” by pressing **[▼]** or **[▲]**, then press **[▶]**.
- 3** Scroll to “**LCD contrast**” by pressing **[▼]** or **[▲]**, then press **[▶]**.
- 4** Press **[▼]** or **[▲]** repeatedly to select the desired setting.
- 5** Press **[Save]**, then press **[OFF]**.

Display language

You can select either “**English**” (default) or “**Español**” as the display language.

- 1** Press **[MENU]**.
- 2** Scroll to “**Initial setting**” by pressing **[▼]** or **[▲]**, then press **[▶]**.
- 3** Scroll to “**Change language**” by pressing **[▼]** or **[▲]**, then press **[▶]**.
- 4** Press **[▼]** or **[▲]** repeatedly to select the desired language.
 - You can also select by pressing **[English]** or **[Español]**.
- 5** Press **[Save]** or **[Salvar]**, then press **[OFF]**.

Note:

- If you select a language you cannot read, press **[MENU] [0] [8] [1] [Save]** to change the display language to English.

Telephone settings

Dialing mode

If you cannot make calls, change this setting depending on your telephone line service.

“**Tone**” (default): For tone dial service.

“**Pulse**”: For rotary pulse dial service.

- 1 Press **[MENU]**.
- 2 Scroll to “**Initial setting**” by pressing **[▼]** or **[▲]**, then press **[▶]**.
- 3 Scroll to “**set tel line**” by pressing **[▼]** or **[▲]**, then press **[▶]**.
- 4 Scroll to “**set dial mode**” by pressing **[▼]** or **[▲]**, then press **[▶]**.
- 5 Press **[▼]** or **[▲]** repeatedly to select the desired setting.
- 6 Press **[Save]**, then press **[OFF]**.

Flash time

The flash time depends on your telephone exchange or host PBX.

You can select: “**90ms**” (milliseconds), “**100ms**”, “**110ms**”, “**250ms**”, “**300ms**”, “**400ms**”, “**600ms**”, or “**700ms**” (default).

- 1 Press **[MENU]**.
- 2 Scroll to “**Initial setting**” by pressing **[▼]** or **[▲]**, then press **[▶]**.
- 3 Scroll to “**set tel line**” by pressing **[▼]** or **[▲]**, then press **[▶]**.
- 4 Scroll to “**set flash time**” by pressing **[▼]** or **[▲]**, then press **[▶]**.
- 5 Press **[▼]** or **[▲]** repeatedly to select the desired setting.
- 6 Press **[Save]**, then press **[OFF]**.

Note:

- The setting should stay at 700 ms unless pressing **[Flash]** fails to pick up the Call Waiting call.
- If the unit is connected via a PBX, certain PBX functions (call transferring, etc.) may not work correctly. Consult your PBX supplier for the correct setting.

Line mode

The line mode is preset to “**B**” and generally should not be adjusted. If “**Line in use**” on the handset is not displayed properly, the line mode selection is incorrect. Set line mode to “**A**”.

- 1 Press **[MENU]**.
- 2 Scroll to “**Initial setting**” by pressing **[▼]** or **[▲]**, then press **[▶]**.
- 3 Scroll to “**set tel line**” by pressing **[▼]** or **[▲]**, then press **[▶]**.
- 4 Scroll to “**set line mode**” by pressing **[▼]** or **[▲]**, then press **[▶]**.
- 5 Press **[▼]** or **[▲]** repeatedly to select the desired setting.
- 6 Press **[Save]**, then press **[OFF]**.

Other options

Handset key tone

You can select whether or not key tones are heard when keys are pressed. Includes confirmation tones and error tones. The default setting is ON.

- 1 Press **[MENU]**.
- 2 Scroll to “Initial setting” by pressing **[▼]** or **[▲]**, then press **[▶]**.
- 3 Scroll to “Key tone” by pressing **[▼]** or **[▲]**, then press **[▶]**.
- 4 Press **[▼]** or **[▲]** repeatedly to select “on” or “off”.
- 5 Press **[Save]**, then press **[OFF]**.

Re-registering the handset

If “No link to base. Move closer to base, try again.” is displayed even when the handset is near the base unit, you may need to re-register the handset to the base unit.

Important:

- Make sure the base unit is not being used.
- Have the handset and base unit near each other when re-registering the handset.
- KX-TG5439 only:
Confirm the extension number of the handset which has lost the communication by placing the handset on the base unit or charger.
If you re-register the handset using the other handset’s extension number [1] or [2], the other handset will not function.

- 1 **Handset:**
Press **[MENU]**.

- 2 Scroll to “Initial setting” by pressing **[▼]** or **[▲]**, then press **[▶]**.
- 3 Scroll to “Registration” by pressing **[▼]** or **[▲]**, then press **[▶]**.
- 4 **KX-TG5438 base unit:**
Press and hold **[LOCATOR/INTERCOM]** until the CHARGE indicator flashes.
KX-TG5439 base unit:
Press and hold the locator/handset button that corresponds to the handset you want to re-register (**[LOCATOR/INTERCOM 1]** or **[LOCATOR/INTERCOM 2]**) until the registering handset number (*H 1* or *H 2*) is displayed.
 - After the CHARGE indicator starts flashing, the rest of the procedure must be completed within 1 minute.
- 5 **Handset:**
Press **[OK]**, then wait until the handset beeps.
 - Registration is complete.

Time adjustment (Caller ID subscribers only)

Using this feature, the unit's date and time setting will be automatically adjusted when caller information is received. To turn this feature on, select "Caller ID [auto]" (default). To turn off, select "Manual".

- 1 Press **[MENU]**.
- 2 Scroll to "Initial setting" by pressing **[▼]** or **[▲]**, then press **[▶]**.
- 3 Scroll to "Time adjustment" by pressing **[▼]** or **[▲]**, then press **[▶]**.
- 4 Press **[▼]** or **[▲]** repeatedly to select "Manual" or "Caller ID [auto]".
- 5 Press **[Save]**, then press **[OFF]**.

Note:

- To use this feature, set the date and time manually first (page 16).

Customer support

The handset can display the Internet address where you can download operating instructions for this product using your computer.

- 1 Press **[MENU]**.
- 2 Scroll to "Customer support" by pressing **[▼]** or **[▲]**, then press **[▶]**.
 - "www.panasonic.com/support" will be displayed.
- 3 Press **[OFF]**.

Programming via direct commands

You can also program most features using “direct commands”—special codes that take you directly to the feature you wish to program and allow you to select the desired setting. There is no need to scroll through the unit’s menus.

Details of each feature can be found on the corresponding pages.

- 1** Press **[MENU]**.
- 2** Enter the desired feature code (shown below).
- 3** Enter the desired setting code (shown below).
 - This step may vary depending on the feature being programmed.
- 4** Press **[Save]**.
- 5** Press **[OFF]** to exit programming mode.

Direct commands chart

Feature	Feature code	Setting code	Page
Ringer volume	[1] [1]	[1] : Low [2] : Medium [3] : High [0] : Off	page 34
Ringer tone	[1] [2]	[1]–[3] : Tone pattern 1–3 [4]–[7] : Melody pattern 1–4	page 35
Interrupt tone	[1] [3]	[1] : On [2] : 2 times [0] : Off	page 35
Message play	[2]	–	page 46
Date and time	[4]	Go to step 3 on page 16.	page 16
Voice enhancer	[5]	[1] : On [0] : Off	page 37
Voice changer (Talk)	[8] [1]	[1] : Deep Voice [2] : High Voice [3] : Fun Voice	page 36
Voice changer (Greeting)	[8] [2]	[1] : Deep Voice [2] : High Voice [3] : Fun Voice [0] : Off	page 36
Copy phonebook (1 item) ^{*1}	[#] [1]	Go to step 4 on page 24.	page 24
Copy phonebook (all items) ^{*1}	[#] [2]	–	page 25
LCD contrast	[0] [1]	[1]–[6] : Level 1–6	page 37
Key tone	[0] [2]	[1] : On [0] : Off	page 39
Auto talk	[0] [3]	[1] : On [0] : Off	page 36

Programmable Settings

Feature	Feature code	Setting code	Page
Caller ID number auto edit	[0] [4]	[1] : On [0] : Off	page 37
Set dial mode	[0] [5] [1]	[1] : Pulse [2] : Tone	page 38
Set flash time	[0] [5] [2]	[1] : 700 ms [2] : 600 ms [3] : 400 ms [4] : 300 ms [5] : 250 ms [6] : 110 ms [7] : 100 ms [8] : 90 ms	page 38
Set line mode	[0] [5] [3]	[1] : A [2] : B	page 38
Ring count	[0] [6] [1]	[2] – [7] : 2–7 rings [0] : Toll saver	page 50
Recording time	[0] [6] [2]	[1] : 1 minute [2] : 2 minutes [3] : 3 minutes [0] : Greeting only	page 50
Remote code	[0] [6] [3]	Go to step 5 on page 49.	page 49
Change language	[0] [8]	[1] : English [2] : Spanish	page 37
Message alert	[0] [†]	[1] : On [0] : Off	page 51
Time adjustment	[0] [9]	[1] : Caller ID[auto] [0] : Manual	page 40
Handset registration	[0] [0]	Go to step 4 on page 39.	page 39

*1 KX-TG5439 only

Note:

- If you make a mistake or enter the wrong code, press **[OFF]** then start again by pressing **[MENU]**.

Answering system

The unit contains an answering system which can answer and record calls for you when you are unavailable to answer the phone.

For details about memory capacity, see page 47.

Important:

- Only 1 person can access the answering system (listen to messages, record a greeting message, etc.) at a time.
- When callers leave messages, the unit records the day and time of each message. Make sure the date and time have been set (page 16).
- You can select the caller's recording time (page 50).

Recording your greeting message

You can record your own greeting message (max. 2 minutes) that will be played when the answering system answers a call. If you do not record a greeting message, a pre-recorded greeting message will be used.

Sample greeting message: *"This is (your name). We are unable to answer the phone right now. Please leave a message after the beep. Thank you."*

Important:

- The voice changer feature (page 36) can also be used to modify your voice on your greeting message.

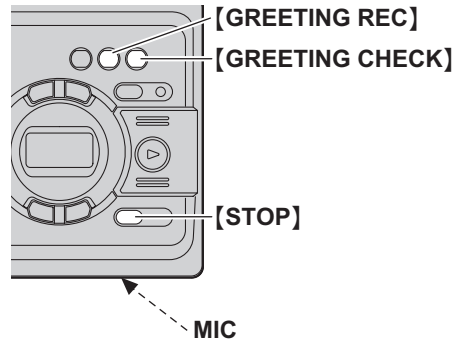

- 1** Press **[GREETING REC]**.
 - The unit announces *"To record greeting, press record again."*
- 2** Within 10 seconds, press **[GREETING REC]** again.
- 3** After the unit beeps, speak clearly about 20 cm (8 inches) away from the MIC.
 - The display will show the elapsed recording time.
- 4** To stop recording, press **[GREETING REC]** or **[STOP]**.

Answering System Features

Note:

- If the greeting message is less than 1 second long, the unit beeps 6 times and announces, “*Your greeting was not recorded. Record your greeting again.*”

To play back the greeting message

Press **[GREETING CHECK]**.

Erasing your greeting message

Press **[GREETING CHECK]**, and then press **[ERASE]** while your greeting message is playing.

- If you do not re-record your greeting message, the unit will use a pre-recorded greeting message.

Pre-recorded greeting message

If you do not record a greeting message, one of 2 pre-recorded messages will be played when a call is received depending on the caller's recording time (page 50).

– When the recording time is set to “1min”, “2min”, or “3min”:

“Hello, we are not available now. Please leave your name and phone number after the beep. We will return your call.”

– When the recording time is set to “Greeting only”:

“Hello, we are not available now. Please call again. Thank you for your call.”

To play back the pre-recorded greeting, press **[GREETING CHECK]**.

Turning the answering system on/off

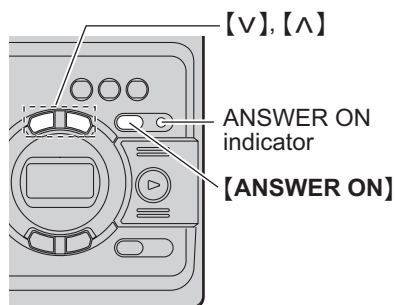

Press **[ANSWER ON]**.

- When the answering system is turned on, the ANSWER ON indicator lights and the unit announces “*Answer set*” and the day and time.
- When the answering system is turned off, the ANSWER ON indicator turns off and the unit announces “*Answer off*”.

Screening your calls

While a caller is leaving a message, you can listen to the call through the base unit's speaker. To adjust the speaker volume, press **[^]** or **[v]** repeatedly. You can answer the call by pressing **[📞]** or **[📞]**.

To turn off the call screening feature

Turn the base unit's speaker volume off by pressing **[v]** until “0” is displayed.

Note:

- If you adjust the speaker volume while listening to messages or talking on the intercom, the speaker volume for call screening will be turned on again.

Listening to messages

When new messages have been recorded:

- The MESSAGE indicator on the base unit will flash.
- The message indicator on the handset will flash slowly if the message alert feature is turned on (page 51).

The base unit display will show the number of messages (old and new) recorded by the answering system.

Example: The total number of recorded messages is 10.



Listening to messages using the base unit

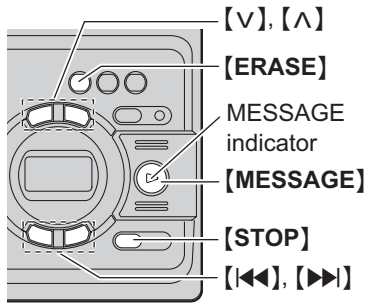

Press **[MESSAGE]**.

- The unit will announce the number of new messages and will play back the new messages.
- When you have no new messages, the unit will announce “No new messages. All message playback”, and will play back all messages.

Note:

- The display shows the message number during playback.
- During playback, the unit will announce the day and time that each message was recorded. (**Voice time/day stamp**)
- At the end of the last message, the unit announces “End of final message”.

To adjust the speaker volume

9 levels (high to off) are available. Press **[^]** or **[v]** repeatedly while using the answering system.

Repeating a message

Press **[◀◀]** while listening to the message.

- If pressed within the first 5 seconds of a message, the previous message will be played.

Skipping a message

Press **[▶▶]** to play the next message.

Pausing message playback

Press **[STOP]**.

- To resume playback, press **[MESSAGE]**.
- To stop playback completely, press **[STOP]** again.

Erasing a specific message

Press **[ERASE]** while listening to the message you want to erase.

Erasing all messages

- 1 Press **[ERASE]** while the base unit is not being used.
 - The unit will announce “To erase all messages, press ERASE again.”
- 2 Within 10 seconds, press **[ERASE]** again.
 - The unit will announce “No messages”.

Answering System Features

Note:

- Caller information for the erased messages will remain in the caller list.

Listening to messages using the handset

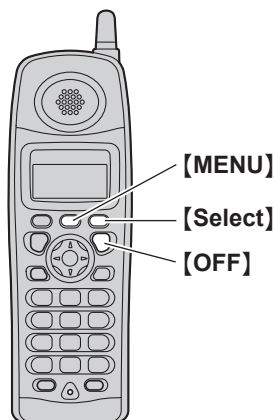

When new messages have been recorded, “**New message**” is displayed.

- 1 Press **[MENU]**.
- 2 Press **[Select]** at “**Message play**”.
 - The unit will announce the number of new messages, and will play back the new messages.
 - When you have no new messages, the unit will announce “*No new messages. All message playback*”, and will play back all messages.
 - After the last message is played back, the unit’s voice guidance starts. Follow the guidance as necessary.
- 3 Press **[OFF]** when finished.

Note:

- While listening to messages, you can switch between the receiver and speaker by pressing **[📞]** or **[📢]**.
- Adjust the speaker or receiver volume using **[▼]** or **[▲]**.

- At the end of the last message, the unit announces “*End of final message*”.

Voice guidance

If you do not press any buttons after the last message is played back, the unit’s voice guidance starts. Operate the answering system by following the guidance as necessary.

The unit will announce “*Press 4 to play back new messages. Press 5 to play back all messages.*”

- You can press buttons for other playback options (see below) even if the voice guidance has started.
- If you do not press any button within 10 seconds after the voice guidance, the handset returns to standby mode.

Answering system commands

You can also operate the answering system by pressing dial keys.

To use the following commands, press **[MENU]**, then press **[Select]** at “**Message play**”.

Key	Command
[1] or [←]	Repeat message (during playback) ^{*1}
[2] or [→]	Skip message (during playback)
[4]	Play new messages
[5]	Play all messages
[8]	Turn answering system on
[9]	Stop playback ^{*2}
[0]	Turn answering system off
[CLEAR] or [*][4]	Erase this message (during playback)
[*][5]	Erase all messages

^{*1} If pressed within the first 5 seconds of a message, the previous message will be played.

^{*2} To resume operation, press a command key within 15 seconds, or the voice guidance will start.

Calling back (Caller ID subscribers only)

If Caller ID information was received for the call, you can call the caller back while listening to a message.

Press **[Call]** during playback.

Note:

- To edit the number before calling back, press **[Edit]** repeatedly to select the desired format (page 28), then press **[Call]**, **[↶]**, or **[↷]**.

Memory capacity

The total recording capacity (including your greeting message and caller messages) is about 15 minutes. A maximum of 64 messages (including a greeting message) can be recorded.

- If message memory becomes full:
 - “**FULL**” flashes on the base unit.
 - the ANSWER ON indicator flashes rapidly (if the answering system is turned on).
 - the unit announces “*Memory full*” when operating the answering system.

To record additional messages, erase unnecessary messages.

- If less than 3 minutes of recording time is available, the unit will announce the remaining recording time when operating the answering system.
- Messages are retained even if a power failure occurs. All messages are saved until you erase them. (**Flash memory message backup**)
- The total recording capacity may be reduced by the calling party's background noise.

Remote operation

Using a touch tone phone, you can call your phone number from outside and access the unit to listen to messages. The unit's voice guidance will prompt you to press certain dial keys to perform different operations.

Important:

- In order to operate the answering system remotely, you must first set a remote code (page 49). This code must be entered each time you operate the answering system remotely.

Using the answering system remotely

- 1 Dial your phone number from a touch tone phone.
 - If the ring count is set to "To11 saver" (page 50), the number of rings you hear will indicate whether or not you have new messages.
- 2 After the greeting message starts, enter your remote code.
 - The unit will announce the number of new messages, and will play back the new messages.
- 3 After 3 seconds, the voice guidance will start. Follow the voice guidance as necessary.
- 4 When finished, hang up.

Note:

- When you press a key, press firmly.
- You can hang up at any time.
- You can ignore the voice guidance and control the unit using remote commands.

Voice guidance

During remote operation, the unit's voice guidance will prompt you to press **[1]** to perform a specific operation, or press **[2]** to listen to more available operations.

Operations are presented by voice guidance in the following order:

- Play back all messages
- Play back new messages
- Record a message
- Erase all messages

Note:

- If you do not press any dial keys within 10 seconds after a voice guidance prompt, the unit will announce, "Thank you for your call" then disconnect your call.
- If less than 3 minutes of recording time is available, the unit will announce the remaining recording time after the last message is played back.
- If the unit announces "Memory full", erase unnecessary messages.

Remote commands

You can press dial keys to access certain answering system functions without waiting for the voice guidance to prompt you.

Key	Remote command
[1]	Repeat message (during playback) ^{*1}
[2]	Skip message (during playback)
[4]	Play new messages
[5]	Play all messages
[9]	Stop ^{*2}
[0]	Turn answering system off
[*][4]	Erase this message (during playback)
[*][5]	Erase all messages

- *1 If pushed within the first 5 seconds of a message, the previous message will be played.
- *2 To resume operation, enter a remote command within 15 seconds, or the voice guidance will start.

Turning on the answering system remotely

If the answering system is off, you can turn it on remotely.

- 1 Dial your phone number.
- 2 Let the phone ring 15 times.
 - The unit will answer your call with the greeting message.
 - You can hang up, or if you call from a touch tone phone, you can enter your remote code and begin remote operation (page 48).

Skipping the greeting message to leave a message

You can leave a message just as any outside caller can. Call your phone number, then press **[*]** to skip the greeting message and record your message after the beep.

Answering system settings

Remote code

A remote code must be entered when operating the answering system remotely. This code prevents unauthorized parties from listening to your messages remotely. Store any 2-digit number (00–99). The default setting is “11”.

- 1 Press **[MENU]**.
- 2 Scroll to “**Initial setting**” by pressing **[▼]** or **[▲]**, then press **[▶]**.
- 3 Scroll to “**set answering**” by pressing **[▼]** or **[▲]**, then press **[▶]**.
- 4 Scroll to “**Remote code**” by pressing **[▼]** or **[▲]**, then press **[▶]**.
- 5 Select the desired remote code by entering a 2-digit number (00–99).
- 6 Press **[Save]**, then press **[OFF]**.

Note:

- To confirm the remote code, repeat steps 1 to 4. Press **[OFF]** when finished.

Ring count

You can change the number of times the phone rings before the unit answers calls. You can select "2", "3", "4" (default), "5", "6", "7", or "Toll saver".

"Toll saver": The unit answers on the 2nd ring when new messages have been recorded, and on the 4th ring when there are no new messages. If you call your phone from outside to listen to new messages (page 48), you will know that there are no messages when the phone rings for the 3rd time. You can then hang up without being charged for the call.

- 1 Press **[MENU]**.
- 2 Scroll to "Initial setting" by pressing **[▼]** or **[▲]**, then press **[▶]**.
- 3 Scroll to "Set answering" by pressing **[▼]** or **[▲]**, then press **[▶]**.
- 4 Scroll to "Ring count" by pressing **[▼]** or **[▲]**, then press **[▶]**.
- 5 Press **[▼]** or **[▲]** repeatedly to select the desired setting.
 - You can also select the ring count by pressing **[0]** ("Toll saver"), or **[2]** to **[7]**.
- 6 Press **[Save]**, then press **[OFF]**.

Caller's recording time

You can change the maximum message recording time allotted to each caller.

"1min", "2min", or "3min" (default): Caller messages are limited to 1 minute to 3 minutes.

"Greeting only": The unit plays the greeting message but does not record caller messages.

- 1 Press **[MENU]**.
- 2 Scroll to "Initial setting" by pressing **[▼]** or **[▲]**, then press **[▶]**.
- 3 Scroll to "Set answering" by pressing **[▼]** or **[▲]**, then press **[▶]**.
- 4 Scroll to "Recording time" by pressing **[▼]** or **[▲]**, then press **[▶]**.
- 5 Press **[▼]** or **[▲]** repeatedly to select the desired setting.
 - You can also select the recording time by pressing **[1]** to **[3]**, or **[0]** ("Greeting only").
- 6 Press **[Save]**, then press **[OFF]**.

Note:

- If message memory becomes full, the unit will automatically switch to the "Greeting only" mode.

Message alert

You can select whether or not the message indicator on the handset will flash when new messages have been recorded (page 45). The default setting is OFF.

- 1** Press **[MENU]**.
- 2** Scroll to “**Initial setting**” by pressing **[▼]** or **[▲]**, then press **[▶]**.
- 3** Scroll to “**Message alert**” by pressing **[▼]** or **[▲]**, then press **[▶]**.
- 4** Press **[▼]** or **[▲]** repeatedly to select “**on**” or “**off**”.
- 5** Press **[Save]**, then press **[OFF]**.

Note:

- The message indicator will not flash for new messages while the handset is in use.
- While message alert is on, battery operating time will be shortened (page 12).

Wall mounting

Base unit

The base unit can be mounted on a wall phone plate.

- 1** Connect the AC adaptor.

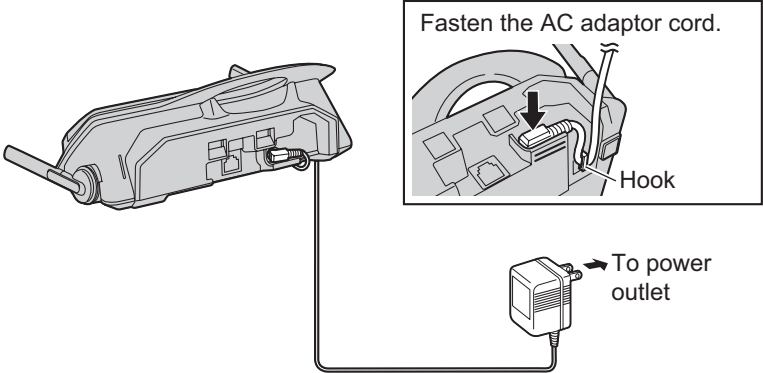

- 2** Tuck the telephone line cord inside the wall mounting adaptor (①).
Connect the telephone line cord (②).

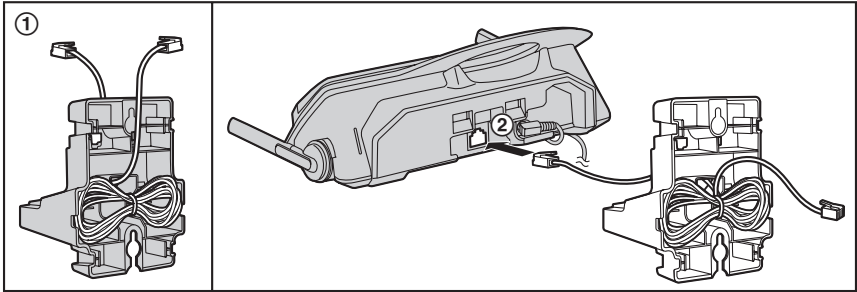

- 3** Insert the hooks on the wall mounting adaptor into the holes (A) and (B) on the base unit.

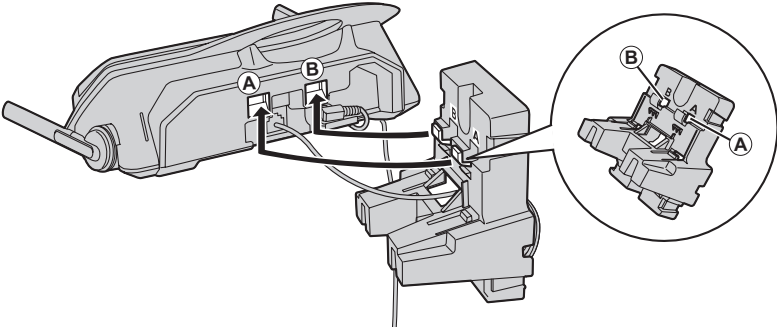

- 4** Adjust the adaptor to hold the base unit, then push it in the direction of the arrow until it clicks into place.

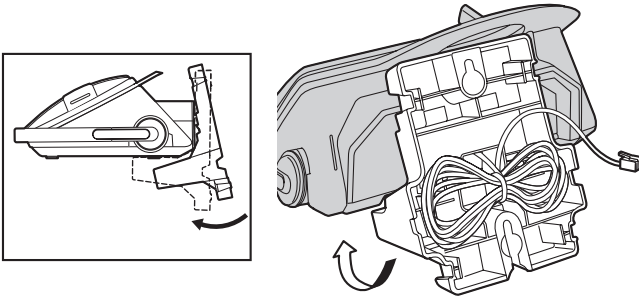

- 5** Connect the telephone line cord. Mount the unit, then slide it down.
- Raise the antennas.

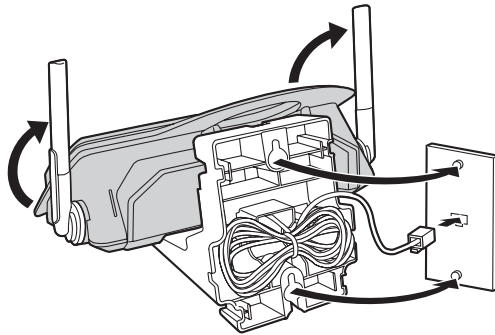

To remove the wall mounting adaptor

While pushing down the release levers (①), remove the adaptor (②).

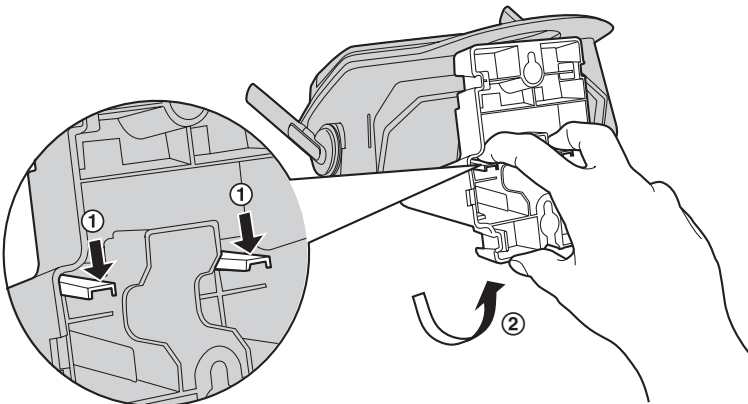

Useful Information

Charger unit (KX-TG5439 only)

The charger can be wall mounted, as shown below.

- 1 Connect the AC adaptor.
- 2 Drive the screws (not included) into the wall using the wall mount template (see below).
- 3 Mount the charger (①).
- 4 Slide it down (②) and to the right (③) until it is secure.

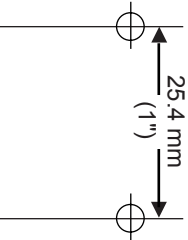
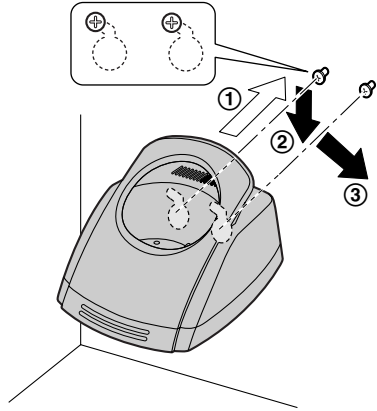
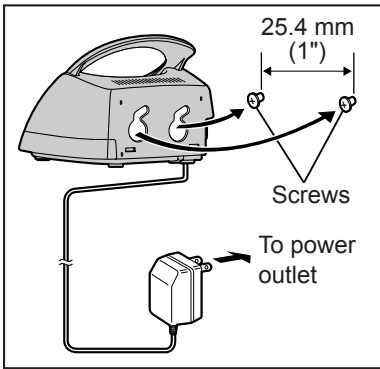

Wall mount template for the charger

Belt clip

You can hang the handset on your belt or pocket using the included belt clip.

To attach the belt clip

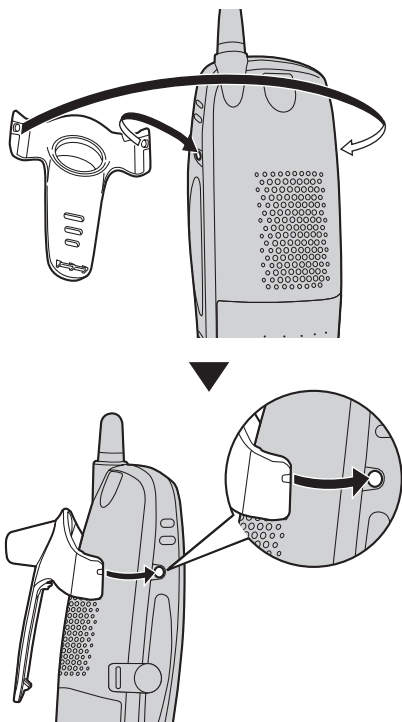

To remove the belt clip

While pressing the top of the clip (①), pull the right edge in the direction of the arrow (②).

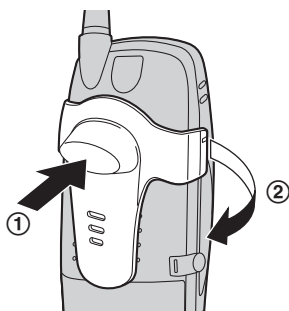

Headset (optional)

Connecting an optional headset to the handset allows hands-free phone conversations. Please use only a Panasonic headset. See page 5 for compatible headsets and ordering information.

To connect an optional headset to the handset

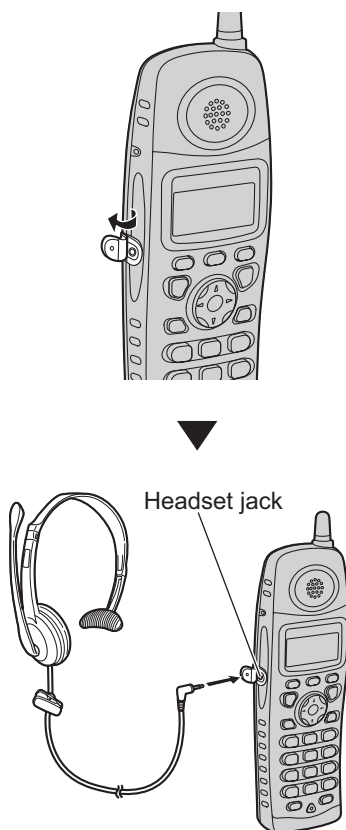

- Model shown is KX-TCA86.

Note:

- To switch to the speakerphone, press . To return to the headset, press .

Error messages

If the unit detects a problem, one of the following messages will be displayed on the handset.

Display message	Cause & solution
Busy	<ul style="list-style-type: none"> ● The called handset is in use.*¹ ● The handset you tried to copy phonebook items to is in use.*¹ ● The handset you are calling is too far from the base unit.*¹
Error!!	<ul style="list-style-type: none"> ● When you tried to register the handset, the handset and the base unit could not link for some reason, such as interference from electrical appliances. Move the handset and the base unit away from the electrical appliances and try again. ● The other handset tried to send phonebook items to you but there was an error. Have the other handset user re-send the items to you (page 24).*¹
---Incomplete--- Phonebook full	<ul style="list-style-type: none"> ● When the phonebook item(s) was(were) sent to another handset, the handset's phonebook memory was full and copying stopped. Press [OFF] to exit. Erase items from the other handset's phonebook (page 23). When phonebook memory is available, you can copy all phonebook items (page 25) or individual items one by one (page 24).*¹
No link to base. Move closer to base, try again.	<ul style="list-style-type: none"> ● The handset has lost communication with the base unit. Move closer to the base unit, and try again. ● Confirm that the base unit's AC adaptor is plugged in. ● Raise the base unit antennas. ● The handset's registration may have been canceled. Re-register the handset (page 39).
Phonebook full	<ul style="list-style-type: none"> ● There is no space to store new items in the phonebook. Erase unnecessary items (page 23).
No items stored	<ul style="list-style-type: none"> ● Your phonebook or redial list is empty.
Please lift up and try again.	<ul style="list-style-type: none"> ● A handset button was pressed while the handset was on the base unit or charger. Lift the handset and press the button again.
System is busy. Please try again later.	<ul style="list-style-type: none"> ● The handset has lost communication with the base unit. Move closer to the base unit and try again. ● More than one unit is in use. Try again later.*¹ ● Another user is listening to messages. Try again later. ● Another user is using the voice changer. Try again later.*¹

*1 KX-TG5439 only

Troubleshooting

General use

Problem	Cause & solution
The unit does not work.	<ul style="list-style-type: none"> ● Make sure that the battery is installed correctly (page 10). ● Check the connections (page 9). ● Fully charge the battery (page 11). ● Clean the charge contacts and charge again (page 11). ● Unplug the base unit's AC adaptor to reset the unit. Reconnect the adaptor and try again. ● Re-install the battery (page 10) and fully charge it.
The display shows "No link to base. Move closer to base, try again." and an alarm tone sounds.	<ul style="list-style-type: none"> ● The handset is too far from the base unit. Move closer and try again. ● Plug in the base unit's AC adaptor. ● Raise the base unit antennas. ● If the above remedies do not solve the problem, the handset may have lost communication with the base unit. Register the handset again (page 39).
I cannot hear a dial tone.	<ul style="list-style-type: none"> ● Confirm that the telephone line cord is connected (page 9). ● Disconnect the unit from the telephone line and connect a known working telephone. If the working telephone operates properly, contact our service personnel to have the unit repaired. If the working telephone does not operate properly, contact your telephone company.

Programmable settings

Problem	Cause & solution
I cannot program items.	<ul style="list-style-type: none"> ● Programming is not possible while the handset and base unit are being used. ● Do not pause for over 1 minute while programming. ● Move closer to the base unit. ● While another user is listening to messages or the answering system is answering a call, you cannot program. Try again later.
While programming, the handset starts to ring.	<ul style="list-style-type: none"> ● A call is being received. Answer the call and start again from the beginning after hanging up.

Making/answering calls, Intercom

Problem	Cause & solution
<p>Static is heard, sound cuts in and out. Interference from other electrical units.</p>	<ul style="list-style-type: none"> ● Move the handset and the base unit away from other electrical appliances. ● Move closer to the base unit. ● Raise the base unit antennas. ● Turn on the clarity booster feature (page 20). ● If your unit is connected to a telephone line with xDSL service, we recommend connecting a noise filter between the base unit and the telephone line jack. Contact your xDSL provider for details.
<p>The handset does not ring.</p>	<ul style="list-style-type: none"> ● The ringer volume is turned off. Adjust it (page 34).
<p>I cannot make a call.</p>	<ul style="list-style-type: none"> ● The dialing mode may be set incorrectly. Set the dial mode (page 38) to match the type of telephone service you have (tone or pulse). ● If the base unit (including answering system) or the other handset is in use, you may not be able to make a call. Try again later. ● While listening to messages using the handset, you cannot make a call. Exit by pressing [OFF].
<p>I cannot redial by pressing [REDIAL].</p>	<ul style="list-style-type: none"> ● If the last number dialed was more than 48 digits long, the number will not be redialed correctly. ● If you press [REDIAL] after you have started dialing, this button functions as the [PAUSE] button. To redial, do not dial any numbers before pressing [REDIAL].
<p>I cannot join an outside call.</p>	<ul style="list-style-type: none"> ● You cannot join the call if the other handset is using voice changer. To join the call, have that handset cancel the voice changer.
<p>I tried to use voice changer during a call, but [(VX)] is not shown on the display.</p>	<ul style="list-style-type: none"> ● You cannot use the voice changer when you are on a conference call.
<p>I cannot have a conversation using the headset.</p>	<ul style="list-style-type: none"> ● Make sure that an optional headset is connected properly (page 55). ● If “SP-phone” is displayed on the handset, press [ to switch to the headset.
<p>I cannot make long distance calls.</p>	<ul style="list-style-type: none"> ● Make sure that you have long distance service.
<p>I cannot page the handset or base unit.</p>	<ul style="list-style-type: none"> ● The called handset is too far from the base unit. ● The called unit is in use. Try again later.

Phonebook

Problem	Cause & solution
I cannot store an item in the phonebook.	<ul style="list-style-type: none"> You cannot store an item in the phonebook while the handset is in talk, speakerphone or intercom mode, or while listening to messages. Do not pause for over 1 minute while storing.
While storing an item in the phonebook, the handset starts to ring.	<ul style="list-style-type: none"> A call is being received. Answer the call and start again from the beginning after hanging up.
Copying stopped with an item displayed.	<ul style="list-style-type: none"> The destination handset may have lost communication with the base unit, or the destination handset user may have pressed [↶] or [↷]. The displayed phonebook item was not copied to the handset. Press [OFF]. Confirm that the destination handset is in standby mode (i.e., not in use) and try again.
The display exits the phonebook while searching.	<ul style="list-style-type: none"> The handset automatically exits after 1 minute of inactivity.

Caller ID

Problem	Cause & solution
The handset does not display the caller's name and/or phone number.	<ul style="list-style-type: none"> You have not subscribed to Caller ID service. Contact your telephone company to subscribe. If your unit is connected to any additional telephone equipment such as Caller ID box or wireless telephone jack, disconnect the unit from the equipment and plug the unit directly into the wall jack. If your unit is connected to a telephone line with xDSL service, we recommend connecting a noise filter between the base unit and the telephone line jack. Contact your xDSL provider for details. The name display service may not be available in some areas. Contact your telephone company for details. Other telephone equipment may be interfering with this unit. Disconnect the other equipment and try again. The caller requested not to send caller information (page 26). If a call is being transferred to you, the caller information will not be displayed. Generally caller information is displayed from the 2nd ring.





Useful Information

Problem	Cause & solution
The caller list/incoming phone numbers are not edited automatically.	<ul style="list-style-type: none"> • The Caller ID number auto edit feature is turned off. Turn it on and try again (page 37). • You need to call back the edited number to activate Caller ID number auto edit.
I cannot dial the phone number edited in the caller list.	<ul style="list-style-type: none"> • The phone number you dialed might have an incorrect edited pattern (for example, the long distance “1” or the area code is missing). Edit the phone number with another pattern (page 28).
The display exits the caller list while searching.	<ul style="list-style-type: none"> • The handset automatically exits after 1 minute of inactivity.

Answering system

Problem	Cause & solution
I cannot listen to messages from a remote location.	<ul style="list-style-type: none"> • A touch tone phone is required for remote operation. • Press the remote code correctly and press each key firmly (page 48). • The answering system is off. Turn it on (page 49).
The other party complains that they cannot leave a voice message.	<ul style="list-style-type: none"> • The recording time is set to “Greeting only”. Select “1min”, “2min”, or “3min” (page 50). • The memory is full. Erase unnecessary messages (page 45).
“ FULL ” flashes and the ANSWER ON indicator flashes rapidly. No new messages are recorded.	<ul style="list-style-type: none"> • Message memory is full. Erase unnecessary messages (page 45).
I cannot operate the answering system.	<ul style="list-style-type: none"> • Someone is operating the answering system. • If someone is using the voice changer or talking on a conference call, you cannot operate the answering system. Try again later.
During message playback, the unit rings and cancels playback.	<ul style="list-style-type: none"> • A call is being received. Answer the call and start again from the beginning after hanging up.
The message indicator on the handset flashes slowly.	<ul style="list-style-type: none"> • New messages have been recorded. Listen to the new messages (page 45) or turn the message alert off (page 51).
When you play back messages or turn on the answering system, the base unit and handset announce the day and time incorrectly.	<ul style="list-style-type: none"> • Set the date and time again (page 16).

Battery charge

Problem	Cause & solution
"Recharge battery" is displayed,  flashes or the handset beeps intermittently.	<ul style="list-style-type: none"> Fully charge the battery (page 11).
"Charge for 6h" and  are displayed and the handset does not work.	<ul style="list-style-type: none"> The battery has been discharged. Fully charge the battery (page 11).
I charged the battery fully, but "Recharge battery" is still displayed and/or  continues to flash, or "Charge for 6h" and  are displayed.	<ul style="list-style-type: none"> Clean the charge contacts and charge again (page 11). The battery may need to be replaced (page 12). If you install a new battery, fully charge it (page 11).
The CHARGE indicator does not go out after the battery has been charged.	<ul style="list-style-type: none"> This is normal.
The handset display is blank.	<ul style="list-style-type: none"> Confirm that the battery is properly installed. Fully charge the battery (page 11).

Power failure

Problem	Cause & solution
The unit will not function.	<ul style="list-style-type: none"> This product is not designed to make calls in the event of a power failure. We recommend connecting a standard telephone to the same telephone line in the event that emergency calls need to be made during a power failure (page 9).

Important information about subscription services

In order to use Caller ID, Call Waiting, or Call Waiting Caller ID (CWID), you must first contact your telephone company and subscribe to the desired service.

- For more information, contact your telephone company.

If the Call Waiting Caller ID (CWID) feature does not function:

- You may need to contact your telephone company to activate this specific service, even if you already subscribed to both Caller ID and Call Waiting with Caller ID services (CWID).

If you subscribe to a flat-rate bundle service that includes Caller ID, Call Waiting, Voice Mail, and unlimited local/regional/long distance calls, please read the following:

- To use the Voice Mail service provided by the telephone company rather than the unit's answering system, turn off the answering system by pressing **[ANSWER ON]** on the base unit.
This unit does not have an indicator to indicate if there are new messages in your mailbox service.

- To use this unit's answering system rather than the Voice Mail service provided by your telephone company, please contact your telephone company to deactivate your Voice Mail service.

If the telephone company cannot do this, set this unit's "Ring count" setting so that this unit's answering system answers calls before the telephone company's Voice Mail service tries to answer your calls. It is necessary to check the ring count required to activate the Voice Mail service provided by your telephone company before changing this setting.

Example: To set the ring count to "2", see page 42.

FCC and other information

This equipment complies with Part 68 of the FCC rules and the requirements adopted by the ACTA. On the bottom of this equipment is a label that contains, among other information, a product identifier in the format US:ACJ-----.

If requested, this number must be provided to the telephone company.

- Registration No
.....(found on the bottom of the unit)
- Ringer Equivalence No.
(REN).....0.1B

A plug and jack used to connect this equipment to the premises wiring and telephone network must comply with the applicable FCC Part 68 rules and requirements adopted by the ACTA. A compliant telephone cord and modular plug is provided with this product. It is designed to be connected to a compatible modular jack that is also compliant.

The REN is used to determine the number of devices that may be connected to a telephone line. Excessive RENs on a telephone line may result in the devices not ringing in response to an incoming call. In most but not all areas, the sum of RENs should not exceed five (5.0). To be certain of the number of devices that may be connected to a line, as determined by the total RENs, contact the local telephone company. For products approved after July 23, 2001, the REN for this product is part of the product identifier that has the format US:AAAEQ##TXXXX. The digits represented by ## are the REN without a decimal point (e.g., 03 is a REN of 0.3).

If this equipment causes harm to the telephone network, the telephone company will notify you in advance that temporary discontinuance of service may be required. But if advance notice isn't practical, the telephone company will

notify the customer as soon as possible. Also, you will be advised of your right to file a complaint with the FCC if you believe it is necessary.

The telephone company may make changes in its facilities, equipment, operations or procedures that could affect the operation of the equipment. If this happens the telephone company will provide advance notice in order for you to make necessary modifications to maintain uninterrupted service.

If trouble is experienced with this equipment, for repair or warranty information, please contact a Factory Servicenter or other Authorized Servicer. If the equipment is causing harm to the telephone network, the telephone company may request that you disconnect the equipment until the problem is resolved.

Connection to party line service is subject to state tariffs. Contact the state public utility commission, public service commission or corporation commission for information.

If your home has specially wired alarm equipment connected to the telephone line, ensure the installation of this equipment does not disable your alarm equipment. If you have questions about what will disable alarm equipment, consult your telephone company or a qualified installer.

This equipment is hearing aid compatible as defined by the FCC in 47 CFR Section 68.316.

Useful Information

When you hold the phone to your ear, noise might be heard in your Hearing Aid. Some Hearing Aids are not adequately shielded from external RF (radio frequency) energy. If noise occurs, use an optional headset accessory or the speakerphone option (if applicable) when using this phone. Consult with your audiologist or Hearing Aid manufacturer about the availability of Hearing Aids which provide adequate shielding to RF energy commonly emitted by digital devices.

WHEN PROGRAMMING EMERGENCY NUMBERS AND(OR) MAKING TEST CALLS TO EMERGENCY NUMBERS:

- 1) Remain on the line and briefly explain to the dispatcher the reason for the call.
- 2) Perform such activities in the off-peak hours, such as early morning or late evenings.

The software contained in this equipment to allow user access to the network must be upgraded to recognize newly established network area codes and exchange codes as they are placed into service.

Failure to upgrade the premises systems or peripheral equipment to recognize the new codes as they are established will restrict the customer and the customer's employees from gaining access to the network and to these codes.

This device complies with Part 15 of the FCC Rules. Operation is subject to the following two conditions:

(1) This device may not cause harmful interference, and (2) this device must accept any interference received, including interference that may cause undesired operation.

Privacy of communications may not be ensured when using this phone.

CAUTION:

Any changes or modifications not expressly approved by the party responsible for compliance could void the user's authority to operate this device.

NOTE:

This equipment has been tested and found to comply with the limits for a Class B digital device, pursuant to Part 15 of the FCC Rules. These limits are designed to provide reasonable protection against harmful interference in a residential installation. This equipment generates, uses, and can radiate radio frequency energy and, if not installed and used in accordance with the instructions, may cause harmful interference to radio communications. However, there is no guarantee that interference will not occur in a particular installation. If this equipment does cause harmful interference to radio or television reception, which can be determined by turning the equipment off and on, the user is encouraged to try to correct the interference by one or more of the following measures:

- Reorient or relocate the receiving antenna.
- Increase the separation between the equipment and receiver.
- Connect the equipment into an outlet on a circuit different from that to which the receiver is connected.
- Consult the dealer or an experienced radio/TV technician for help.

Some cordless telephones operate at frequencies that may cause interference to nearby TVs and VCRs. To minimize or prevent such interference, the base of the cordless telephone should not be placed near or on top of a TV or VCR. If interference is experienced, move the cordless telephone further away from the TV or VCR. This will often reduce, or eliminate, interference.

FCC RF Exposure Warning:

This product complies with FCC radiation exposure limits set forth for an uncontrolled environment. To comply with FCC RF exposure requirements the base unit must be installed and operated with its antenna located 20 cm or more between antenna and all person's body (excluding extremities of hands, wrist and feet). The handset unit may be carried and operated with only the specific provided belt-clip. Other non-tested belt-clips or similar body-worn accessories may not comply and must be avoided. The base and handset units must not be co-located or operated in conjunction with any other antenna or transmitter.

openLCR service for the Caller IQ feature

This unit is compatible with service provided by openLCR.

Important:

See the leaflet included with this unit for more information.

- **If you have any questions regarding the openLCR service, visit www.openLCR.com or call openLCR at 1-866-openLCR (1-866-673-6527).**
- **NEITHER PANASONIC COMMUNICATIONS CO., LTD. NOR PANASONIC CORPORATION OF NORTH AMERICA IS IN ANY WAY AFFILIATED WITH, OR RESPONSIBLE FOR THE ACTS OR OMISSIONS OF, OPENLCR.COM, INC. NEITHER PANASONIC COMMUNICATIONS CO., LTD. NOR PANASONIC CORPORATION OF NORTH AMERICA NOR ANY OF THEIR EMPLOYEES OR AFFILIATES OR CUSTOMERS MAKE ANY WARRANTIES OR REPRESENTATIONS, EITHER EXPRESS OR IMPLIED, TO ANY CUSTOMER OR ANY OTHER THIRD PARTY WITH RESPECT TO ANY OF THE SERVICES PROVIDED BY OPENLCR.COM, INC., NOR ASSUME NOR CREATE ANY OTHER OBLIGATION OF ANY KIND ON BEHALF OF OPENLCR.COM, INC.**
- The Caller IQ service can only be activated after registering with openLCR at www.openLCR.com. More information regarding the openLCR service is available on the Internet at www.openLCR.com.

Technical information

Base unit

Operating environment:

5 °C – 40 °C (41 °F – 104 °F)

Frequency:

5.76 GHz – 5.84 GHz

Dimensions:

Approx. height 75 mm x width 185 mm x depth 119 mm ($2^{15}/_{16}$ " x $7^{9}/_{32}$ " x $4^{11}/_{16}$ ")

Mass (Weight):

Approx. 395 g (0.87 lb.)

Power consumption:

Standby: Approx. 2.3 W

Maximum: Approx. 5.5 W

Power supply:

AC adaptor (120 V AC, 60 Hz)

Handset

Operating environment:

5 °C – 40 °C (41 °F – 104 °F)

Frequency:

5.76 GHz – 5.84 GHz

Dimensions:

Approx. height 178 mm x width 53 mm x depth 37 mm (7 " x $2^{3}/_{32}$ " x $1^{15}/_{32}$ ")

Mass (Weight):

Approx. 190 g (0.42 lb.)

Power supply:

Ni-MH battery (3.6 V, 830 mAh)

Security codes:

1,000,000

Charger unit (KX-TG5439 only)

Operating environment:

5 °C – 40 °C (41 °F – 104 °F)

Dimensions:

Approx. height 71 mm x width 89 mm x depth 105 mm ($2^{13}/_{16}$ " x $3^{1}/_{2}$ " x $4^{1}/_{8}$ ")

Mass (Weight):

Approx. 130 g (0.29 lb.)

Power consumption:

Standby: Approx. 0.8 W

Maximum: Approx. 3.0 W

Power supply:

AC adaptor (120 V AC, 60 Hz)

Note:

- Design and specifications are subject to change without notice.
- The illustrations in these instructions may vary slightly from the actual product.

Warranty

PANASONIC CONSUMER
ELECTRONICS COMPANY, DIVISION
OF PANASONIC CORPORATION OF
NORTH AMERICA
One Panasonic Way,
Secaucus, New Jersey 07094

PANASONIC PUERTO RICO, INC.
San Gabriel Industrial Park,
Ave. 65 de Infantería, Km. 9.5,
Carolina, Puerto Rico 00985

Panasonic Telephone Products Limited Warranty

Limited Warranty Coverage

If your product does not work properly because of a defect in materials or workmanship, Panasonic Consumer Electronics Company or Panasonic Puerto Rico, Inc. (collectively referred to as "the warrantor") will, for the length of the period indicated on the chart below, which starts with the date of original purchase ("Limited Warranty period"), at its option either (a) repair your product with new or refurbished parts, or (b) replace it with a new or a refurbished product. The decision to repair or replace will be made by the warrantor.

Parts	Labor
One (1) Year	One (1) Year

During the "Labor" Limited Warranty period there will be no charge for labor. During the "Parts" Limited Warranty period, there will be no charge for parts. You must mail-in your product during the Limited Warranty period. This Limited Warranty excludes both parts and labor for batteries, antennas, and cosmetic parts (cabinet). This Limited Warranty only applies to products purchased and serviced in the United States or Puerto Rico. This Limited Warranty is extended only to the original purchaser and only covers products purchased as new.

Mail-In Service

For assistance in the continental U.S.A. in obtaining repairs please ship the product to:

Panasonic Services Company Customer Servicenter

4900 George McVay Drive Suite B Door #12 McAllen, TX 78503

For assistance in Puerto Rico call Panasonic Puerto Rico, Inc. (787)-750-4300 or fax (787)-768-2910.

For Limited Warranty service for headsets if a headset is included with this product please call Panasonic Call Center at 1-800-211-PANA (7262).

When shipping the unit carefully pack, include all accessories, and send it prepaid, adequately insured and preferably in the original carton. Include a letter detailing the complaint and provide a day time phone number where you can be reached.

IF REPAIR IS NEEDED DURING THE LIMITED WARRANTY PERIOD THE PURCHASER WILL BE REQUIRED TO FURNISH A SALES RECEIPT/PROOF OF PURCHASE INDICATING DATE OF PURCHASE, AMOUNT PAID AND PLACE OF PURCHASE. CUSTOMER WILL BE CHARGED FOR THE REPAIR OF ANY UNIT RECEIVED WITHOUT SUCH PROOF OF PURCHASE.

Limited Warranty Limits And Exclusions

This Limited Warranty ONLY COVERS failures due to defects in materials or workmanship, and DOES NOT COVER normal wear and tear or cosmetic damage. The Limited Warranty ALSO DOES NOT COVER damages which occurred in shipment, or failures which are caused by products not supplied by the warrantor, or failures which result from accidents, misuse, abuse, neglect, mishandling, misapplication, alteration, faulty installation, set-up adjustments, misadjustment of consumer controls, improper maintenance, power line surge, lightning damage, modification, introduction of sand, humidity or liquids, commercial use such as hotel, office, restaurant, or other business or rental use of the product, or service by anyone other than a Factory Servicenter or other Authorized Servicer, or damage that is attributable to acts of God.

THERE ARE NO EXPRESS WARRANTIES EXCEPT AS LISTED UNDER "LIMITED WARRANTY COVERAGE". THE WARRANTOR IS NOT LIABLE FOR INCIDENTAL OR CONSEQUENTIAL DAMAGES RESULTING FROM THE USE OF THIS PRODUCT, OR ARISING OUT OF ANY BREACH OF THIS LIMITED WARRANTY. (As examples, this excludes damages for lost time, lost calls or messages, cost of having someone remove or re-install an installed unit if applicable, travel to and from the servicer. The items listed are not exclusive, but are for illustration only.) **ALL EXPRESS AND IMPLIED WARRANTIES, INCLUDING THE WARRANTY OF MERCHANTABILITY, ARE LIMITED TO THE PERIOD OF THE LIMITED WARRANTY.**

Some states do not allow the exclusion or limitation of incidental or consequential damages, or limitations on how long an implied warranty lasts, so the exclusions may not apply to you.

This Limited Warranty gives you specific legal rights and you may also have other rights which vary from state to state. If a problem with this product develops during or after the Limited Warranty period, you may contact your dealer or Servicenter. If the problem is not handled to your satisfaction, then write to the warrantor's Consumer Affairs Department at the addresses listed for the warrantor.

PARTS AND SERVICE, WHICH ARE NOT COVERED BY THIS LIMITED WARRANTY, ARE YOUR RESPONSIBILITY.

Customer services

Customer Services Directory

Obtain Product Information and Operating Assistance; locate your nearest Dealer or Servicenter; purchase Parts and Accessories; or make Customer Service and Literature requests by visiting our Web Site at:

<http://www.panasonic.com/consumersupport>

or, contact us via the web at:

<http://www.panasonic.com/contactinfo>

You may also contact us directly at: 1-800-211-PANA (7262),
Monday-Friday 9 am-9 pm; Saturday-Sunday 10 am-7 pm, EST.

TTY users (hearing or speech impaired users) can call 1-877-833-8855.

Accessory Purchases

Purchase Parts, Accessories and Instruction Books online for all Panasonic Products by visiting our Web Site at:

<http://www.pasc.panasonic.com>

or, send your request by E-mail to:

npcparts@us.panasonic.com

You may also contact us directly at:

1-800-332-5368 (Phone) 1-800-237-9080 (Fax Only)

(Monday - Friday 9 am to 8 pm, EST.)

Panasonic Services Company

20421 84th Avenue South, Kent, WA 98032

(We Accept Visa, MasterCard, Discover Card, American Express, and Personal Checks)

TTY users (hearing or speech impaired users) can call 1-866-605-1277.

Service in Puerto Rico

Panasonic Puerto Rico, Inc.

San Gabriel Industrial Park, Ave. 65 de Infantería, Km. 9.5,

Carolina, Puerto Rico 00985

Phone (787)750-4300, Fax (787)768-2910

Index

- A** Accessories: 5
 - Answering calls: 18
 - Answering system: 43
 - Auto talk: 18, 36
- B** Backlit display: 15
 - Backlit handset keypad: 15
 - Base unit location: 8
 - Battery
 - Charge: 11
 - Installation: 10
 - Performance: 12
 - Replacement: 12
 - Strength: 11
 - Belt clip: 55
- C** Caller ID edit: 37
 - Caller ID number auto edit: 28
 - Caller ID service: 26
 - Caller list
 - Calling back: 27
 - Editing: 28
 - Erasing: 29
 - Storing: 29
 - Viewing: 27
 - Call screening: 44
 - Call share: 20
 - Call Waiting Caller ID: 26
 - Call waiting tone: 21
 - Chain dial: 24
 - Clarity booster: 20
 - Conf (Conference): 32
 - Conference calls: 32
 - Controls: 13
 - Copy phonebook: 24, 25
 - Customer support: 40
- D** Date and time: 16
 - Dialing mode: 38
 - Display
 - Base unit: 15
 - Handset: 15
 - Display language: 37
- E** Erasing all messages: 45, 46, 48
 - Erasing a message: 45, 46, 48
 - Error messages: 56
 - Extension number: 31
- F** FCC and other information: 63

- Flash button: 21
- Flash time: 38
- Function menu
 - Direct commands: 41
 - Table: 33
- G** Greeting message: 43
- H** Handset locator: 30, 31
 - Headset, optional: 55
 - Hold: 19
- I** Installation
 - AC adaptor: 9
 - Base unit: 9
 - Charger unit: 9
 - Telephone line cord: 9
- Intercom
 - Call: 30
 - Paging: 30
- Interrupt tone: 35
- K** Key tone: 39
- L** LCD contrast: 37
 - Light-up ID: 27
 - Line mode: 38
 - Listening to messages
 - Base unit: 45
 - Handset: 46
 - Touch tone phone: 48
- M** Making calls: 17
 - Memory capacity: 47
 - Message alert: 51
 - Microphone
 - Base unit: 30, 43
 - Handset: 17
 - Mute: 19
- N** Navigator key: 14
 - Noise: 8
- P** Pause: 21
 - Phonebook
 - Adding: 22
 - Calling: 23
 - Copying: 24, 25
 - Editing: 23
 - Erasing: 23
 - Names: 22
 - Power failure: 9, 16, 61
 - Pulse service: 21
- R** Recording time: 50
 - Redial: 17

- Redial list: 18
- Registration: 39
- Remote code: 49
- Remote operation: 48
- Ring count: 50
- Ringer
 - Tone: 35
 - Volume: 34
- Ringer ID: 26
- Ringer off: 18, 34
- Rotary service, tone dialing: 21
- S** Safety instructions: 6
- Soft keys: 15
- SP-phone: 17
- T** Technical information: 66
- Time adjustment: 40
- Toll saver: 50
- Transferring a call: 32
- Troubleshooting
 - Answering system: 60
 - Battery charge: 61
 - Caller ID: 59
 - General use: 57
 - Making/answering calls, Intercom:
58
 - Phonebook: 59
 - Power failure: 61
 - Programmable settings: 57
- TTY: 5
- V** VE (voice enhancer): 20
- Voice changer: 19, 36
- Voice enhancer: 20, 37
- Voice guidance: 46, 48
- Volume control
 - Base unit: 45
 - Handset receiver: 17
 - Handset speaker: 17
- VX (voice changer): 19
- W** Wall mounting
 - Base unit: 52
 - Charger unit: 54
- Warranty: 67

If you need assistance with setup or operation;

- 1** Visit our website: <http://www.panasonic.com/consumersupport>
- 2** Contact us via the web at: <http://www.panasonic.com/contactinfo>
- 3** Call us at: 1-800-211-PANA (7262)
TTY users (hearing or speech impaired users) can call 1-877-833-8855.

When you ship the product;

- Carefully pack your unit, preferably in the original carton.
- Attach a letter, detailing the symptom, to the outside of the carton.
- Send the unit to Panasonic Services Company Customer Servicenter, prepaid and adequately insured.
- Do not send your unit to Panasonic Consumer Electronics Company listed below or to executive or regional sales offices. These locations do not repair consumer products.

- This cordless telephone is designed for use in the United States of America. Sale or use of this product in other countries may violate local laws.
- Ce téléphone sans fil est conçu pour être utilisé aux États-Unis d'Amérique. La vente ou l'emploi de cet appareil dans certains autres pays peut constituer une infraction à la législation locale.
- Este teléfono inalámbrico fue elaborado para uso en los Estados Unidos de América. La venta o el empleo de este producto en ciertos países puede constituir violación de la legislación local.
- このコードレス電話機は、日本国外での使用を目的として設計されており、日本国内での使用は法律違反となります。従って、当社では日本国内においては原則として修理などのサービスは致しかねます。

Copyright:

This material is copyrighted by Panasonic Communications Co., Ltd., and may be reproduced for internal use only. All other reproduction, in whole or in part, is prohibited without the written consent of Panasonic Communications Co., Ltd.

© 2004 Panasonic Communications Co., Ltd. All Rights Reserved.

**Panasonic Consumer Electronics Company,
Division of Panasonic Corporation of North America**
One Panasonic Way, Secaucus, New Jersey 07094

Panasonic Puerto Rico, Inc.
San Gabriel Industrial Park, Ave. 65 de Infantería, Km. 9.5,
Carolina, Puerto Rico 00985